

# ARCORA® GROUP

## PROFESSIONAL CLEANING SYSTEMS



HOTEL  
LINE

**ARCORA®**  
[www.arcora-group.com](http://www.arcora-group.com)



Sustainability is gaining increasing importance and is firmly anchored in ARCORA®'s corporate philosophy. For ARCORA®, a company that looks beyond the horizon, responsibility towards people, the environment, and society is of great significance. Sustainability has been a core value for us from the beginning. In all our products and processes, we consistently ensure that, in addition to economic considerations, we do not neglect social and environmental aspects, always acting with a future-oriented approach.

## THREE-PILAR MODEL

We are an internationally operating company and bear a special responsibility towards people, our environment, and society. Sustainability is ingrained in our daily practices, guided by the principle: 'Making a difference for generations.' We align ourselves with the Three-Pillar Model to continuously improve. Thinking about tomorrow today and assuming responsibility towards people, the environment, and society is inherent in our company.

### Social Sustainability:

In line with Corporate Social Responsibility, we advocate for the well-being of individuals within the company and society as a whole.

### Environmental Sustainability:

We safeguard the environment and natural ecosystems in the production, distribution, and consumption of our products.

### Economic Sustainability:

Quality, service, innovation, and other factors form the basis for our continuous growth.



## FOR A LIVEABLE ENVIRONMENT, EVEN IN THE FUTURE!

As a company, we aim to make a contribution to counteract global climate change. Therefore, we have certified ourselves as a climate-neutral company and our products as climate-neutral. This involves offsetting generated CO<sub>2</sub> emissions and supporting climate protection projects. We want to sustainably contribute to keeping our environment livable for the benefit of future generations.



### CARBON NEUTRALITY - FOR THE SAKE OF THE ENVIRONMENT®

Direct and indirect greenhouse gas emissions are analyzed and reduced throughout our entire business process. We strive to do this by using resources efficiently, minimizing waste, environmentally-friendly disposal, developing products from recycled materials, and promoting awareness of climate change and sustainability among employees and stakeholders. Since emissions cannot be completely avoided, we, as a company, have taken compensatory measures to offset these emissions.

The purchase of CO<sub>2</sub> certificates enables emissions reduction through climate protection projects in India, Indonesia, Turkey, and other countries. We are continually working to certify more products as carbon-neutral, always considering the required standards, which are regularly audited by an independent entity.



## SOCIAL THINKING - RESPONSIBLE ACTIONS

CSR (Corporate Social Responsibility) for ARCORA® means more than just a social component, as the literal translation suggests; it holds significant value. We aspire to continually improve our products and processes to establish optimal solutions for sustainability. To achieve this, we have set goals that decisively influence our daily activities: in resource-efficient production, in our responsibility towards employees, customers, suppliers, and throughout our entire value chain.



The ARCORA® GROUP is committed to taking social and environmental responsibility beyond economic activities, acting with fairness and ethics. Bearing responsibility towards employees, business partners, suppliers, society, and the environment is natural for us and an integral part of our corporate philosophy. For us, CSR is much more than just a certification; it encompasses sustainable and responsible business practices that are firmly integrated and anchored in the ARCORA® corporate strategy.

## SUSTAINABLE SUPPLY CHAIN



Producing products from recycled materials to conserve resources, reduce waste, and minimize environmental impact is part of our sustainability ethos, which also holds great importance in our production and supply chain.

With ARCORA®'s ECOBLACK TECHNOLOGY, recycled materials from old, empty battery casings are processed into robust and durable plastic, saving a significant amount of CO<sub>2</sub>.



The RCS Standard (Recycled Claim Standard) is used for tracing recycled raw materials within a supply chain, ensuring a transparent evaluation and verification of the accuracy of information regarding the content of recycled materials in a product. Our facilities obtained this certificate last year, confirming that our cotton and blended yarn covers are made, to a certain extent, from recycled materials.



The **ARCORA® GROUP** has been a professional supplier of products and solutions for the cleaning and hygiene industry for more than 30 years. We have been striving to continually improve our products and processes to offer you as your point of contact for cleanliness and hygiene, top-notch solutions for your cleaning and hygiene needs. With 5 in-house facilities and over 1,400 products, 'Everything from one source' and directly from the manufacturer, we have become a solid player in the international cleaning market. Continuous development of new products for all professional cleaning needs with a focus on environmental friendliness, high efficiency and quality, as well as user-friendliness, has enabled us to offer a diverse product portfolio.

We focus on the specific requirements of our customers and rely on innovative technologies and tailored solutions, always with an eye on sustainability and environmental compatibility, to contribute to the protection of our environment and society. The result: continuous development of amazing innovations, environmentally friendly products with high efficiency and quality at fair prices, for your benefit and for the well-being of our environment.

Thanks to our know-how, expertise acquired over the years, and constant collaboration with our customers who support us worldwide year after year with praise and feedback, we continuously develop new products for all professional cleaning needs.

With our company philosophy, we will continue to meet new market requirements and quality standards early and dynamically. Therefore, more and more customers and future-oriented companies are choosing to work with our products. Worldwide, we can look back on long-standing and successful business relationships with our customers.

In order to make your guests' stay in your hotel as pleasant as possible, we would like to support you with our range selection in the hotel hygiene sector. We focus on your individual needs in order to be able to offer your guests the service you desire.

Our staff is always available to assist you in selecting the right products and cleaning and hygiene concepts.



*Looking ahead is one of the most crucial tasks of our time.  
This is achieved by combining powerful parameters into a holistic strategy,  
all while recognizing and meeting the complex demands of the market.*

For a clean future,

Sami Memili  
**CEO / PRESIDENT**  
ARCORA® GROUP



HOUSEKEEPING

CLEANING-& CARE PRODUCTS WITH ACCESSORIES

<b>NEUTRA7</b>	NEUTRAL SANITARY ODOR CLEANER FOR MAINTENANCE CLEANING	12
<b>KARMA® PEARL</b>	SANITARY MAINTENANCE CLEANER WITH PEARL EFFECT	12
<b>BILANZ® FRESH</b>	SANITARY MAINTENANCE CLEANER	12
<b>BIO-LIVE®</b>	BIOLOGICAL CLEANER AND ODOR ELIMINATOR	12
<b>WALES</b>	SKIN CLEANSING AND SHOWER LOTION	12
<b>CITRUS® FRESH</b>	NEUTRAL CLEANER	13
<b>PURPLE FRESH</b>	NEUTRAL CLEANER	13
<b>ORANGE FRESH</b>	NEUTRAL CLEANER	13
<b>SO-KLAR RTU</b>	READY TO USE GLASS AND PLASTIC CLEANER	13
<b>SPOTEX RTU</b>	POWERFUL CARPET STAIN REMOVER	14
<b>TENAS 4IN1</b>	CARPET CLEANER WITH ENCAPSULATION SYSTEM	14
<b>TENAS HAND BRUSH</b>		14
<b>POLISH-LINE</b>	HIGH-PILE EDGELESS CLOTH	14
<b>MICROFIBER CLOTH</b>		
<b>DOSING AIDS</b>		15
<b>MULTI TOOL BELT WORK BAG</b>	WORK BAG WITH BELT BLACK	15

CLEANING TEXTILES

<b>BASIC-LINE MICROFIBER CLOTH</b>	BLUE/GREEN/YELLOW/PINK/GREY	16
<b>TOP-LINE MICROFIBER CLOTH</b>	BLUE/GREEN/YELLOW/PINK/GREY	16
<b>SOFT-LINE MICROFIBER CLOTH</b>	BLUE/GREEN/YELLOW/PINK/WHITE/GREY	16
<b>SCRUB &amp; CLEAN 2IN1</b>	BLUE/GREEN/YELLOW/PINK/GREY	16
<b>MICROFIBER CLOTH</b>		
<b>FINE-LINE MICROFIBER CLOTH</b>	BLUE	16
<b>MICRO BLUE 2.0-FC</b>	WITHOUT COVER SHEET	17
<b>RUNNER BLUE 2.0-FC</b>	WITHOUT COVER SHEET	17
<b>ULTRA MICRO BLUE VELCRO</b>	WITH VELCRO BACK	17
<b>MOP COVER</b>		
<b>ULTRA RUNNER BLUE VELCRO</b>	WITH VELCRO BACK	17
<b>MOP COVER</b>		
<b>ARCORA® COPPER PRODUCTS</b>	COPPER SPONGE AND COPPER CLOTH	18
<b>PROFI GRIP CLEANING SPONGE</b>	BLUE-WHITE/GREEN-WHITE/YELLOW-GREEN/ YELLOW-WHITE/PINK-WHITE	18
<b>PU-PAD SPONGE</b>	BLUE/GREEN/YELLOW/RED	18
<b>PROFI MELAMINE</b>	STAIN REMOVER SPONGE	18
<b>POWER-CLEAN</b>		
<b>DISPOSABLE FLEECE CLOTH</b>	WHITE	18
<b>IMPREGNATED</b>		

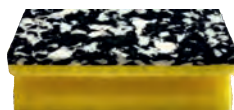

HOUSEKEEPING

CLEANING SYSTEMS & ACCESSORIES

<b>ULTRA TRAPEZE MOP HOLDER</b>	BLUE WITH FOAM AND VELCRO STRAP	19
<b>PROFESSIONAL MOP HOLDER STANDARD</b>	GREY OR BLUE	19
<b>PROFESSIONAL MOP HOLDER MAGNET</b>	GREY OR BLUE	19
<b>HANDPAD HOLDER WITH HANDLE HOLDER</b>	BLUE	19
<b>HANDPAD HOLDER WITH FIXED HANDLE</b>	BLUE	19
<b>ALUMINIUM HANDLE</b>	BLUE/GREEN/RED/YELLOW/GREY	19
<b>PROFESSIONAL TELESCOPIC HANDLE 2-PART</b>	GREY-BLACK	20

CLEANING- AND POLISHING PADS

<b>HANDPAD THICK</b>	BLACK/DARK BROWN/GREEN/BLUE/RED/WHITE	20
<b>HANDPAD ORIGINAL MICROFIBER</b>	WHITE WITH VELCRO BACK	20
<b>HANDPAD SOFT MICROFIBER</b>	WHITE WITH POLYAMIDE BRISTLE STRIPS AND VELCRO BACK	20
<b>ROUNDPAD MICRO-BLUE</b>	FOR INTERMEDIATE CLEANING ON TEXTILE FLOOR COVERINGS	20

ECOBBLACK TROLLEYS AND ACCESSORIES

<b>ECOBBLACK 45</b>	DOUBLE BUCKET WITH DRIP TRAY	21
<b>ECOBBLACK 100</b>	SERVICE TROLLEY	21
<b>TOOLS HOLDER</b>	ACCESSORY HOLDER	21

CLEANING MACHINES AND ACCESSORIES

<b>ECOBBLACK S9Q</b>	VACUUM CLEANER MADE FROM RECYCLED PLASTIC	22
<b>ECOBBLACK S9Q FLEECE FILTER BAG 3-LAYERS</b>	WHITE	22
<b>PRO1PLUS</b>	PROFESSIONAL COMMERCIAL VACUUM CLEANER WITH COOLING SYSTEM	23
<b>PRO1PLUS FLEECE FILTER BAG 3-LAYERS</b>	WHITE	23
<b>PRO1PLUS TEXTILE FILTER BAG</b>	REUSABLE	23
<b>MAGIC SUCTION NOZZLE</b>	UNIVERSAL FOR ALL VACUUM CLEANERS	23
<b>PRO1PLUS TURBO NOZZLE</b>	WITH BRUSH ROLL	23

COMING SOON

<b>PROFESSIONAL HOTEL TROLLEY-LINE CARRIER FOR CLEANING STAFF</b>		24
		24



## KITCHEN HYGIENE

### CLEANING-& CARE PRODUCTS WITH ACCESSORIES

<b>INPUR®</b>	ALKALINE DEGREASER / POWERFUL KITCHEN CLEANER	26
<b>FAT-CLEAN RTU</b>	READY-TO-USE POWERFUL KITCHEN CLEANER	26
<b>CHLORADO</b>	KITCHEN CLEANER WITH ACTIVE CHLORINE	26
<b>POWER-CLEAN</b>	GRILL CLEANER AND RESIN REMOVER	26
<b>GRILL-CLEAN RTU</b>	LOW-ODOR HIGH-ALKALINE GRILL CLEANER	26
<b>ORKAN</b>	COLD STORAGE CLEANER UP TO -30°C	27
<b>EDOL 2IN1</b>	STAINLESS STEEL CLEANER AND CARE IN ONE	27
<b>BIO-LIVE®</b>	BIOLOGICAL CLEANER AND ODOR ELIMINATOR	27
<b>CLEATOR</b>	LIME SCALE REMOVER FOR COMMERCIAL MACHINES	27
<b>CITRUS POWER</b>	PREMIUM HAND DISH SOAP WITH CITRUS POWER	27
<b>PROTAP 2IN1</b>	DISHWASHING CONCENTRATE AS TAB	27
<b>ECO PLUS</b>	DISHWASHER DETERGENT FOR DISHWASHERS	28
<b>ECO PLUS-CF</b>	CHLORINE-FREE DISHWASHER DETERGENT	28
<b>ECO GLS</b>	GLASSWARE DETERGENT FOR DISHWASHERS	28

### CLEANING MACHINES

<b>WD 36 P</b>	WET/DRY VACUUM CLEANER WITH 36 LITER TANK VOLUME	28
----------------	--	----

### CLEANING TEXTILES

<b>EXCELLENT ABRASIVE MOP</b>	WITH COVER SHEET	29
<b>DB-FC GREY-WHITE</b>		
<b>EXCELLENT SCRUB-IGEL</b>	WITHOUT COVER SHEET	29
<b>MICROFIBER MOP</b>		
<b>SCRUB &amp; CLEAN 2IN1</b>	BLUE/GREEN/YELLOW/PINK/GREY	29
<b>MICROFIBER CLOTH</b>		
<b>GLASS-SHINE MICROFIBER</b>	WHITE	29
<b>GLASS POLISH CLOTH</b>		
<b>MULTI-SHINE MICROFIBER</b>	BLUE	29
<b>DISH TOWEL</b>		
<b>ARCORA® COPPER PRODUCTS</b>	COPPER SPONGE AND COPPER CLOTH	30
<b>PROFI GRIP CLEANING SPONGE</b>	BLUE-WHITE/GREEN-WHITE/YELLOW-GREEN/ YELLOW-WHITE/PINK-WHITE	30
<b>PU-PAD SPONGE</b>	BLUE/GREEN/YELLOW/RED	30
<b>METAL POT CLEANER</b>	40 g	30
<b>STAINLESS STEEL SPIRAL</b>	40 g	30



**PUBLIC AREA**

**CLEANING-& CARE PRODUCTS WITH ACCESSORIES**

<b>TERMINATOR® RTU</b>	READY-TO-USE POWER SPRAY CLEANER	32
<b>IDEAL</b>	ALKALINE PORCELAIN TILE CLEANER	32
<b>SCHACHMATT® RTU</b>	PLASTIC AND DESK CLEANER	32
<b>CITRUS® FRESH</b>	NEUTRAL CLEANER	32
<b>PURPLE FRESH</b>	NEUTRAL CLEANER	32
<b>ORANGE FRESH</b>	NEUTRAL CLEANER	32
<b>FLEXAL®</b>	POWERFUL MULTI-PURPOSE CLEANER	33
<b>SO-KLAR RTU</b>	READY TO USE GLASS AND PLASTIC CLEANER	33
<b>WINDOW-CLEAN</b>	PROFESSIONAL WINDOW CLEANER SOAP	33
<b>NEUTRA7</b>	NEUTRAL SANITARY ODOR CLEANER FOR MAINTENANCE CLEANING	34
<b>KARMA® PEARL</b>	SANITARY MAINTENANCE CLEANER WITH PEARL EFFECT	34
<b>BIO-LIVE®</b>	BIOLOGICAL CLEANER AND ODOR ELIMINATOR	34

**CLEANING TEXTILES**

<b>MICRO BLUE 2.0-FC</b>	WITHOUT COVER SHEET	34
<b>EXCELLENT ABRASIVE MOP</b>	WITH COVER SHEET	34
<b>DB-FC GREY-WHITE</b>		
<b>TOP-LINE MICROFIBER CLOTH</b>	BLUE/GREEN/YELLOW/PINK/GREY	35
<b>SCRUB &amp; CLEAN 2IN1</b>	BLUE/GREEN/YELLOW/PINK/GREY	35
<b>MICROFIBER CLOTH</b>		
<b>FINE-LINE MICROFIBER CLOTH</b>	BLUE	35
<b>GLASS-SHINE MICROFIBER</b>	WHITE	35
<b>GLASS POLISH CLOTH</b>		
<b>PU-PAD SPONGE</b>	BLUE/GREEN/YELLOW/RED	35

**CLEANING SYSTEMS & ACCESSORIES**

<b>WARNING SIGN PENGUIN</b>	BLUE/GREEN/YELLOW/RED	34
<b>SWEEPING SET DELUXE</b>	TURQUOISE-DARK GREY	35

**ECOBBLACK TROLLEY / HYGIENE TROLLEY AND ACCESSORIES**

<b>ECOBBLACK 750</b>	SERVICE TROLLEY	36
<b>BORA MEDICAL 750</b>	HYGIENE TROLLEY	36
<b>TOOLS HOLDER</b>	ACCESSORY HOLDER	36

**CLEANING MACHINES AND ACCESSORIES**

<b>ARCORA® 510BM/50L</b>	SCRUBBER DRYER MACHINE	37
<b>ARCORA® RO-MAN 660BR/90L</b>	RIDE-ON SCRUBBER DRYER MACHINE	38

**SPECIAL CLEANING**

**CLEANING-& CARE PRODUCTS WITH ACCESSORIES**

<b>PALACE LIQ HAMMER®</b>	SPECIAL CLEANER FOR NATURAL AND ARTIFICIAL STONE	40
<b>EXBETAN-X</b>	DIRT BREAKER/HIGH-PERFORMANCE CLEANER	40
<b>MOSS &amp; ALGAE REMOVER LIQ</b>	WORKSHOP AND INDUSTRIAL CLEANER	40
<b>SANEX</b>	FOR REMOVING ORGANIC CONTAMINANTS ON STONES	40
<b>SALPUREX 3IN1</b>	SANITARY DEEP CLEANER	40
<b>GROUT CLEANER RTU</b>	URINE/LIMESTONE REMOVER AND CEMENT RESIDUE REMOVER	40
<b>TERMINATOR® RTU</b>	PROFESSIONAL GROUT CLEANER	41
<b>TENAS 4IN1</b>	READY-TO-USE POWER SPRAY CLEANER	41
<b>TENAS GRANULATE</b>	CARPET CLEANER WITH ENCAPSULATION SYSTEM	41/44
<b>TENAS HAND BRUSH</b>	CARPET CLEANING GRANULATE WITH ENCAPSULATION SYSTEM	41/44
<b>POLISH-LINE</b>		41
<b>MICROFIBER CLOTH</b>	HIGH-PILE EDGELESS CLOTH	41

**CLEANING- AND POLISHING PADS**

<b>SUNSHINE STRONG PLUS No1+/ DARK BROWN</b>	STEP1+	42
<b>SUNSHINE STRONG PLUS No1/ RED</b>	STEP 1	42
<b>SUNSHINE MULTI No2/BLUE</b>	STEP 2	42
<b>SUNSHINE FINE No3/YELLOW</b>	STEP 3	42
<b>SUNSHINE FINAL No4/GREEN</b>	STEP 4	42
<b>SUNSHINE GOAL No5/OLIVE</b>	STEP 5	42

**CLEANING MACHINES AND ACCESSORIES**

<b>SD 17</b>	SINGLE DISC MACHINE INCL. ACCESSORIES	43
<b>ORBITAL HEAVY OR17</b>	ORBITAL MACHINE	43
<b>WD 36 P</b>	WET/DRY VACUUM CLEANER WITH 36 LITER TANK VOLUME	43
<b>ANIKO 350 DUO BRUSH</b>	ROTARY BRUSH SYSTEM MACHINE	44
<b>ANIKO 60</b>	SPRAY EXTRACTION MACHINE	44

**INNOVATIVE CLEANING**

<b>ULTRA MOBILE SPRAY MOP SYSTEM</b>	FAST, EFFICIENT AND BUCKETLESS CLEANING	46
<b>ARCORA PU-PAD LIGHT</b>	THE IDEAL PAD FOR MAINTENANCE CLEANING WITH SMALLER SCRUBBER DRYER MACHINES	47



# HOUSEKEEPING

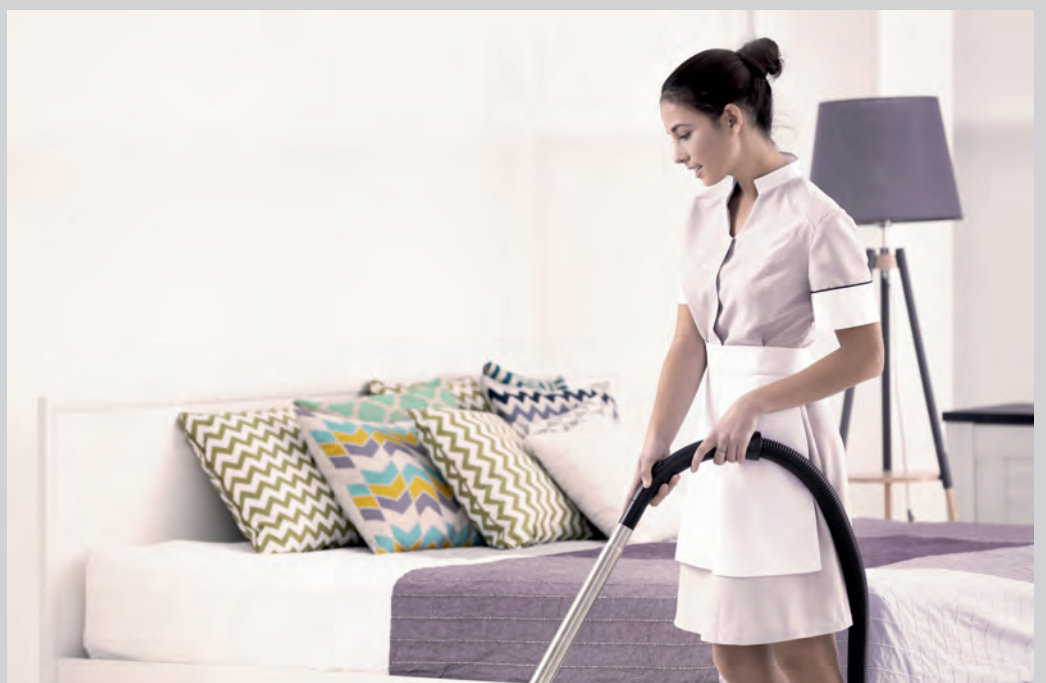



## NEUTRA7

pH 7-7,5



### NEUTRAL SANITARY ODOR CLEANER FOR MAINTENANCE CLEANING

Sanitary odor cleaner with a long-lasting and deodorizing fresh scent and patented Neofresh technology.

- Quickly removes skin oils, cosmetic residues, soap residues, limescale, organic dirt, water spots, etc.
- Regular use prevents limescale buildup
- Dries streak-free without the need for additional drying due to the beading effect

Container	Item No.	Unit
1 l Bottle	01157	12x1 l
10 l Canister	01158	1x10 l



## KARMA<sup>®</sup> Pearl

pH 1,5



### SANITARY MAINTENANCE CLEANER WITH PEARL EFFECT

Sanitary maintenance cleaner for daily cleaning in the entire wet area. Dissolves limescale, uric acid, soap, oil, and grease residues. The pearl effect reduces re-soiling and deposits on surfaces.

- Enhancement through polymer surface-active substances (beading effect)
- Streak-free, fast-drying, highly glossy, and protected surfaces
- Maintenance cleaning is significantly facilitated, reducing cleaning time

Container	Item No.	Unit
1 l Bottle	01019	12x1 l
10 l Canister	01002	1x10 l



## BILANZ<sup>®</sup> Fresh

pH 0,5



### SANITARY MAINTENANCE CLEANER

Fast-acting acid-based sanitary maintenance cleaner with a sustainable fresh scent that effortlessly removes limescale residues, soap scum, uric acid, limescale-bound fats, rust, and grease.

- Very good material compatibility, dries quickly and streak-free
- Regular use prevents limescale buildup
- Suitable for use on intact chrome and other sanitary fittings as well as for foam triggers

Container	Item No.	Unit
1 l Bottle	01049	12x1 l
10 l Canister	01039	1x10 l



## BIO-LIVE<sup>®</sup>

pH 8,6-8,9



### BIOLOGICAL CLEANER AND ODOR ELIMINATOR

The odor eliminator eradicates even stubborn odors, e.g., in garbage bins, laundry depots, toilets, washrooms, etc. The included cultures (living microorganisms) also break down deeply embedded dirt and stains, eliminating bad odors.

- Also suitable for treating stains on carpets, fabrics, tablecloths, and bed linens
- Leaves a long-lasting pleasant scent

Container	Item No.	Unit
1 l Bottle	01096	12x1 l
5 l Canister	01082-05	1x5 l



**BAD SMELL...**  
 ...from your drain?  
 ...from the trash cans?  
 Or have your hotel room  
 guests smoked?



**Not anymore with BIO-LIVE!**  
**With BIO-LIVE, odors are completely  
 eliminated and not just masked with  
 scented oil!**



## WALES

pH 5,7



### SKIN CLEANSING AND SHOWER LOTION

High-quality skin cleansing lotion for gentle cleaning and care of the skin with a fresh melon scent. Leaves a noticeably pleasant feeling on the skin due to the valuable washing and care substances.

- Mild and nourishing, pH value adapted to the skin
- Can be used as a soap cream and as a shower gel in all areas

Container	Item No.	Unit
500 ml Bottle	01188	9x500 ml
5 l Canister	01186	1x5 l
10 l Canister	01187	1x10 l





## CITRUS<sup>®</sup> Fresh

### NEUTRAL CLEANER

Highly concentrated, universally applicable maintenance cleaner for streak-free cleaning of hard, water-resistant surfaces and floors, such as plastics, painted surfaces, glass, mirrors, ceramic, stainless steel.

- Leaves a radiant shine and a pleasant **citrus scent**
- Dries quickly and streak-free
- Highly concentrated, therefore very economical



Container	Item No.	Unit
1 l Bottle	01055	12x1 l
10 l Canister	01060	1x10 l



## PURPLE Fresh

### NEUTRAL CLEANER

Highly concentrated, universally applicable maintenance cleaner for streak-free cleaning of hard, water-resistant surfaces and floors, such as plastics, painted surfaces, glass, mirrors, ceramic, stainless steel.

- Leaves a radiant shine and a pleasant **berry scent**
- Dries quickly and streak-free
- Highly concentrated, therefore very economical



Container	Item No.	Unit
1 l Bottle	01217	12x1 l
10 l Canister	01218	1x10 l



## ORANGE Fresh

### NEUTRAL CLEANER

Highly concentrated, universally applicable maintenance cleaner for streak-free cleaning of hard, water-resistant surfaces and floors, such as plastics, painted surfaces, glass, mirrors, ceramic, stainless steel.

- Leaves a radiant shine and a pleasant **orange scent**
- Dries quickly and streak-free
- Highly concentrated, therefore very economical



Container	Item No.	Unit
1 l Bottle	01345	12x1 l
10 l Canister	01344	1x10 l



## SO-KLAR RTU

### READY-TO-USE GLASS AND PLASTIC CLEANER

Ready-to-use cleaner with a fresh summer scent for streak-free cleaning. Effortlessly removes dirt deposits, grease, and oil from glossy surfaces such as windows, glass, mirrors, plastic, frames, and automotive windows.

- **SPRAY - WIPE ONCE - DONE!**
- Cleans quickly, residue-free, and streak-free
- For radiant shine and cleanliness
- Gentle on skin and materials
- 500 ml spray bottle with a convenient spray head



Container	Item No.	Unit
500 ml Bottle	01035	20x500 ml
1 l Bottle	01024	12x1 l
10 l Canister	01023	1x10 l







## SPOTEX RTU

pH 9,5



### POWERFUL CARPET STAIN REMOVER

Fast-acting, powerful carpet stain remover for the removal of water and solvent-soluble dirt on carpets, upholstery, and other textile surfaces.

- Gently and deeply removes stains such as coffee, cola, fruit juices, shoe polish, etc.
- Suitable for all color- and water-resistant textile surfaces
- 500 ml spray bottle with a convenient spray head

Container	Item No.	Unit
500 ml Bottle	01225	20x500 ml



## TENAS 4IN1

pH 6-7



### CARPET CLEANER WITH ENCAPSULATION SYSTEM

The system performs the tasks of **five** classic carpet cleaners: Only one product for stain removal, pre-cleaning, extraction cleaning, bonnet cleaning, and the dry cleaning system with the ANIKO 350 DUO BRUSH. Dirt is broken down, bound, and encapsulated.

- Polymers prevent re-soiling and graying
- Shortens drying time, protects carpet fibers
- Saves time, money, and space

Container	Item No.	Unit
1 l Bottle	01008	12x1 l
5 l Canister	01028-05	1x5 l



## TENAS HAND BRUSH

TENAS hand brush with foam and bristles for targeted stain removal on upholstery and carpets. With dosing handle for cleaning chemicals. Ideally suited for smaller areas.

- Ideal for cleaning smaller and hard-to-reach areas
- Brushes provide the necessary mechanical friction, and the foam ensures optimal foam distribution

Item No.	Unit
01254	1 pcs.



**Step 1:**  
Unscrew TENAS hand brush.

**Step 2:**  
Fill TENAS 4IN1 up to the first mark.

**Step 3:**  
Dilute with water up to the last mark. Screw the brush head onto the dosing handle.

**Step 4:**  
Dose the chemical by pressing the dosing handle. Work on the stain, rubbing from the outside in.



**Step 5:**  
Use the Polish-Line cloth to absorb dirt and excess chemicals after cleaning with the handbrush.

## POLISH-LINE MICROFIBER CLOTH HIGH-PILE EDGELESS

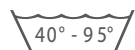

### BLUE

Fluffy microfiber cloth that is ideal for use as a polishing cloth. Thanks to the soft high pile, it has a high dirt absorption capacity. Ideal for auto detailing.

- Maximum absorption of dirt and water thanks to the high pile
- Above-average lifespan

Size   Weight	Item No.	Unit
40 x 40 cm   ca. 62 g/cloth	APOL4040BL	20x10 pcs.



DOSING AIDS



Product	Item No.	Unit
Dosage attachment 20 ml for 1 l Bottle	101691	1 pcs.
Dosage pump 30 ml for 10 l Canister	101529	1 pcs.
Filling tap for 10 l Canister	101429	1 pcs.



MULTI TOOL BELT WORK BAG

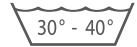

WORK BAG WITH BELT BLACK

Versatile work bag for ergonomic and flexible work in hotels, gastronomy, building cleaning, etc.

- With a comfortable and adjustable belt
- Water-resistant and tear-resistant polyester materials
- 3 storage pockets for spray bottle & cleaning textiles
- 2 flexible carabiner hooks for tools & accessories

Size   Weight	Item No.	Unit
52 x 31 cm   ca. 175 g	MTB5231SC	1 pcs.



For an ergonomic & flexible cleaning

Removable, flexible carabiner hooks



Water-resistant polyester material

Storage pockets

Adjustable hip belt



## BASIC-LINE MICROFIBER CLOTH

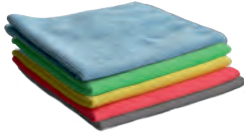

### BLUE/GREEN/YELLOW/PINK/GREY

The optimal and inexpensive object cloth for maintenance and basic cleaning. Can be used on all surfaces thanks to the soft and soft fleece. Suitable for use in the final cleaning.

- Soft fleece
- Excellent cleaning results
- Shape stable and universally applicable

Size   Weight	Item No.	Unit
40 x 40 cm   ca. 30 g/cloth	ABL3838BL	20x10 pcs.
	ABL3838GR	
	ABL3838GE	
	ABL3838RO	
	ABL3838GU	



## TOP-LINE MICROFIBER CLOTH



### BLUE/GREEN/YELLOW/PINK/GREY

The cloth for maintenance cleaning of sensitive surfaces without scratching them. Effortlessly removing of grease stains, fingerprints, dust which ensuring clean, streak-free surfaces.

- Double-stitched edge protection and additional quality edging tape
- Average lifetime
- Maximum absorption capacity for dirt and water

Size   Weight	Item No.	Unit
40 x 40 cm   ca. 50 g/cloth	ATL4040BL	20x10 pcs.
	ATL4040GR	
	ATL4040GE	
	ATL4040RO	
	ATL4040SC	



## SOFT-LINE MICROFIBER CLOTH

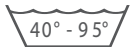

### BLUE/GREEN/YELLOW/PINK/WHITE/GREY

Soft cloth that absorbs the smallest particles thanks to static charging and capillary action. Ideal for maintenance cleaning and polishing work. For optimal and lint-free cleaning results.

- Average lifetime
- Applicable on all surfaces
- Double stitched edge protection and additional quality binding tape
- Maximum absorption power of dirt and water

Size   Weight	Item No.	Unit
40 x 40 cm   ca. 52 g/cloth	ASL4040BL	20x10 pcs.
	ASL4040GR	
	ASL4040GE	
	ASL4040RO	
	ASL4040WE	
	ASL4040GU	



## SCRUB & CLEAN 2IN1 MICROFIBER CLOTH

Alternative to cleaning sponge!

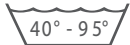

### BLUE/GREEN/YELLOW/PINK/GREY

The cloth is ideal for stubborn dirt and crust, especially in the kitchen and bathroom.

- With abrasive bristle side and soft microfiber side
- Excellent dirt-dissolving power thanks to the abrasive bristle side
- High dirt and water absorption thanks to the microfiber side
- For thorough and scratch-free cleaning on surfaces



Size   Weight	Item No.	Unit
40 x 40 cm   ca. 45 g/cloth	ASC4040BL	30x5 pcs.
	ASC4040GR	
	ASC4040GE	
	ASC4040RO	
	ASC4040GU	



## FINE-LINE MICROFIBER GLASS CLOTH



### BLUE

"A must for glass cleaning." This cloth enables streak-free and lint-free cleaning of glass, mirrors, and chrome.

- Double-stitched edge protection, additional quality edging tape
- Average lifetime
- Maximum absorption capacity for dirt and water
- Super-absorbent: Absorbs 8 times its weight in liquid

Size   Weight	Item No.	Unit
40 x 40 cm   ca. 52 g/cloth	AFL4040BL	20x10 pcs.







### MICRO BLUE 2.0-FC

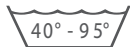

#### WITHOUT COVER SHEET

The dirt wonder among mop covers. Optimal for maintenance cleaning, wet and dry cleaning of elastic coverings, hard floors, laminate floors, as well as smooth and porous floor coverings. Particularly suitable for use in healthcare.

- Improved mechanics and optimal cross-linking of the cleaning solution on the floor due to the tightly woven microfiber yarn
- The yarn composition ensures excellent dirt and water absorption as well as higher surface performance

Size   Weight	Item No.	Unit
40 cm   ca. 85 g	AEMB40FC	75 pcs.
50 cm   ca. 120 g	AEMB50FC	50 pcs.

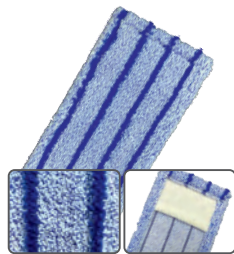

### RUNNER BLUE 2.0-FC

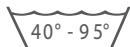

#### WITHOUT COVER SHEET

The smooth-running sensation among mop covers thanks to polyamide smooth-runner bristles. Ideal for maintenance cleaning, wet and dry cleaning of elastic coverings, hard floors, laminate floors, as well as smooth and porous floor coverings. Particularly suitable for use in healthcare.

- The yarn composition ensures excellent dirt and water absorption as well as higher surface performance
- Improved mechanics and optimal cross-linking of the cleaning solution on the floor due to the tightly woven microfiber yarn
- Outstanding gliding properties on almost all surfaces for fatigue-free work

Size   Weight	Item No.	Unit
40 cm   ca. 88 g	ERB40FC	75 pcs.
50 cm   ca. 128 g	ERB50FC	50 pcs.

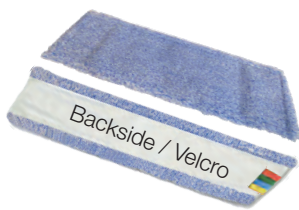

Various colors possible

### ULTRA MICRO BLUE VELCRO MOP COVER

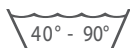

#### WITH VELCRO BACK

Ideal for maintenance cleaning and wet and dry cleaning of elastic coverings, hard floors, laminate floors, as well as smooth and porous floors. Optimal dirt-dissolving power and high surface performance.

- Outstanding dirt and water absorption
- Improved mechanics, optimal cross-linking of the cleaning solution
- Dirt wonder

Size   Weight	Item No.	Unit
40 cm   ca. 92 g	UKM40MB	*
60 cm   ca. 103 g	UKM60MB	*

Compatible with the ARCORA® ULTRA MOBILE SPRAY MOP SYSTEM



\*Units on request

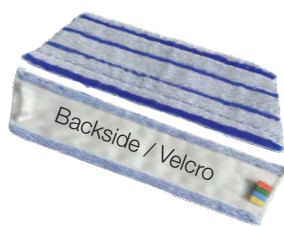

Various colors possible

### ULTRA RUNNER BLUE VELCRO MOP COVER

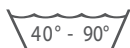

#### WITH VELCRO BACK

Ideal for maintenance cleaning and wet and dry cleaning of elastic coverings, hard floors, laminate floors, as well as smooth and porous floors. Optimal dirt-dissolving power and high surface performance.

- Smooth-running sensation thanks to polyamide smooth-runner bristles
- Improved mechanics, optimal cross-linking of the cleaning solution

Size   Weight	Item No.	Unit
40 cm   ca. 92 g	UKM40RB	*
60 cm   ca. 103 g	UKM60RB	*

Compatible with the ARCORA® ULTRA MOBILE SPRAY MOP SYSTEM





## ARCORA® COPPER PRODUCTS

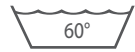

### COPPER SPONGE AND COPPER CLOTH

Concrete residue, graffiti, lime, adhesive residues, hairspray, and silicones? No problem for copper products. They ensure gentle cleaning of pots, sinks, faucets, pans, enamel, glass, mirrors, ceramic hobs, stainless steel, and non-painted metal parts. Even rust spots on cutlery can be removed.

- Only water is needed for cleaning
- Scratch-free application
- Reusable multiple times, washable at 60°C
- Antibacterial

Product	Size   Weight	Item No.	Unit
Copper Sponge	13 x 9 x 2,8 cm   ca. 22 g	01240	100 pcs.
Large Copper Cloth	16 x 19 cm   ca. 25 g	01238	
Small Copper Cloth	10 x 14 cm   ca. 9 g	01239	
Loose Copper Cloth	25 x 25 cm   ca. 34 g	01241	

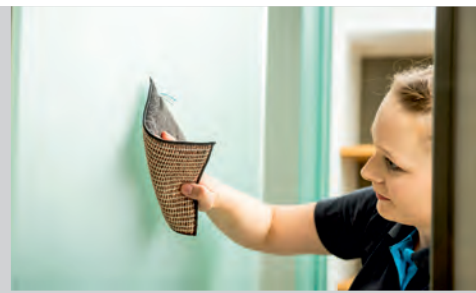

## PROFI GRIP CLEANING SPONGE

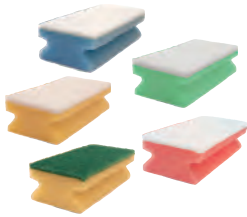

### BLUE-WHITE/GREEN-WHITE/YELLOW-GREEN/YELLOW-WHITE/PINK-WHITE

Durable handle non-woven sponges are ideal for sensitive surfaces. For thorough and scratch-free cleaning.

- High water absorption
- With grip groove to protect hands and fingernails

Size   Weight	Item No.	Unit
150 x 70 x 45 mm   ca. 13 g/Sponge	01141BLW	10x10 pcs.
	01144GRW	
	01145GEG	
	01143GEW	
	01142ROW	

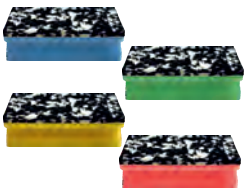

## PU-PAD SPONGE

### BLUE/GREEN/YELLOW/RED

Durable sponge with PU back for damp and wet cleaning of insensitive surfaces. The sponge is ideal for use in the kitchen area, removing stubborn dirt.

- Particularly robust and high water absorption

Size   Weight	Item No.	Unit
150 x 70 x 45 mm   ca. 17 g/Sponge	PU15070BL	28 pcs.
	PU15070GR	
	PU15070GE	
	PU15070RO	



## PROFI MELAMINE POWER-CLEAN



### STAIN REMOVER SPONGE

Effortlessly removes dirt from smooth surfaces using water and without the addition of chemical cleaning agents.

- Flexible applications
- Erases stubborn stains, residues, edges, and streaks

Size	Item No.	Unit
120 x 65 x 30 mm	12653	10 pcs.



## DISPOSABLE FLEECE CLOTH IMPREGNATED



### WHITE

Impregnated cloth for dry cleaning of floor coverings. Ideal for single use. Suitable for daily floor care.

- Removes loose dirt and captures dust
- Airtight and hygienically packed

Size	Item No.	Unit
60 x 25 cm	01192	10x100 pcs.



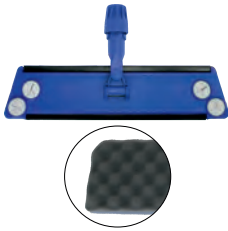

### ULTRA TRAPEZE MOP HOLDER

#### BLUE WITH FOAM AND VELCRO STRAP

A trapeze mop holder with foam for disposable non-woven cloths. Ideal for optimal dust absorption on floor coverings.

- Perfect for cleaning laminate and parquet floors
- Robust and lightweight

Size	Item No.	Unit
40 cm	UTMH40	10 pcs.
60 cm	UTMH60	



### PROFESSIONAL MOP HOLDER STANDARD

#### GREY OR BLUE

Suitable for all common mop covers. The optimized weight and robust construction of the folding holder ensure ergonomic work. Available in two different colors: GRAY or BLUE.

Size	Item No.	Unit
40 cm	PMH40GU	10 pcs.
	PMH40BL	
50 cm	PMH50GU	10 pcs.
	PMH50BL	

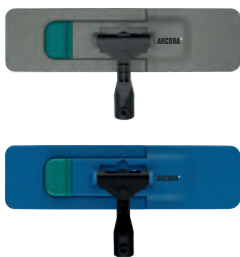

### PROFESSIONAL MOP HOLDER MAGNET

#### GREY OR BLUE

The folding holder has an ideal fit for all common covers. Its optimized weight enables ergonomic work. Available in two different colors: GRAY or BLUE.

Size	Item No.	Unit
40 cm	PMN40GU	10 pcs.
	PMN40BL	
50 cm	PMN50GU	10 pcs.
	PMN50BL	



### HANDPAD HOLDER WITH HANDLE HOLDER

#### BLUE

Robust pad holder for pads. Suitable for use with hand pads.

Size	Item No.	Unit
23 x 10 cm	HPH-SG	50 pcs.



### HANDPAD HOLDER WITH FIXED HANDLE

#### BLUE

Robust pad holder for pads. Suitable for use with hand pads.

Size	Item No.	Unit
23 x 10 cm	HPH-HG	50 pcs.



### ALUMINUM HANDLE 140 cm

#### BLUE/GREEN/RED/YELLOW/GREY

Sturdy aluminum handle with an ergonomic grip in various colors.

- More stable than conventional aluminum handles
- Rust-free material
- Maintains its shape even under strong pressure
- With a rounded tip, suitable for hanging

Size	Item No.	Unit
140 cm	AS140BL	50 pcs.
	AS140GRN	
	AS140RO	
	AS140GE	
	AS140GR	







## PROFESSIONAL TELESCOPIC HANDLE 2-PART

### GREY-BLACK

Robust and ergonomic handle made of high-quality aluminum with a reach of up to 180 cm. Suitable for hanging. With a rubberized handle.

- Length: 96-180 cm
- With a rounded tip, suitable for hanging
- Practical, firmly clamping quick-release



Size	Item No.	Unit
96-180 cm	TST180GU	20 pcs.



## HANDPAD THICK

### BLACK/DARK BROWN/GREEN/BLUE/RED/WHITE

Ideal for cleaning edges and corners.

#### BLACK

Deep cleaning wet and dry, for heavy soiling

#### DARK BROWN

Deep cleaning wet and dry

#### GREEN

Maintenance cleaning, wet scrubbing massaging in waxes and oils

#### BLUE

Scrubbing: sinks, tiles, etc.

#### RED

Scrubbing: sinks, tiles, etc.

#### WHITE

Sensitive surfaces,

Size	Item No.	Unit
250 x 115 x 25 mm	HP250SC	■
	HP250DBR	■
	HP250GR	■
	HP250BL	■
	HP250RO	■
	HP250WE	□
		25 pcs.



## HANDPAD ORIGINAL MICROFIBER

### WHITE WITH VELCRO BACK

For maintenance cleaning of various hard floors and resilient coverings, as well as for wall and ceiling surfaces.

Ideal for smooth floor coverings.

- High dirt-dissolving power
- Above-average lifespan

Size	Item No.	Unit
27 x 14 cm	MFKM-WE	200 pcs.



## HANDPAD SOFT MICROFIBER

### WHITE WITH POLYAMIDE BRISTLE STRIPS AND VELCRO BACK

For maintenance and deep cleaning of various hard floors and resilient coverings, as well as for wall and ceiling surfaces. Ideal for smooth and coated floor coverings.

- Optimal dirt-dissolving power due to special polyamide bristle strips
- High surface performance
- For sealed parquet, only use slightly damp or dry

Size	Item No.	Unit
27 x 14 cm	MFKM-WB	200 pcs.

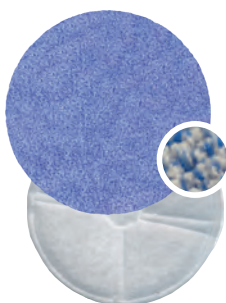

## ROUNDPAD MICRO-BLUE

### FOR INTERMEDIATE CLEANING ON TEXTILE FLOOR COVERINGS

For deep, maintenance and carpet cleaning of various hard floors, elastic floors and carpets.

- Optimum gliding properties and high dirt release power
- Extreme area performance
- Average lifetime
- Carrier: Pad white

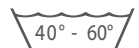

Size	Item No.	Unit
17"= 432 mm	MF43-1-MB	8 pcs.







### ECOBLOCK TECHNOLOGY

With the ECOBLACK TECHNOLOGY by ARCORA®, recycling materials from old, empty battery casings are transformed into robust and durable plastic. This process significantly reduces CO2 emissions compared to manufacturing methods using new/original materials. Therefore, the ECOBLACK series is largely composed of recycled materials.



### ECOBLOCK 45

#### DOUBLE BUCKET WITH DRIP TRAY

Ideal for the quick and easy cleaning of floors. The double bucket is easily and conveniently maneuvered thanks to the four smooth, 360° rotating wheels. It features a sturdy and user-friendly design.

- Black, robust plastic frame
- 2 x 20-liter plastic buckets in black with handles in blue and red
- 1 x plastic press in black
- Side tray for mop holder
- Handle for guiding the cleaning cart with holder for aluminum handle
- With plastic drip tray

Size	Item No.	Unit
710 x 510 x 950 mm	EB45RC	2 Set's



**Gross Weight: 10,00 kg**  
**Net Weight: 8,30 kg**



### ECOBLOCK 100

#### SERVICE TROLLEY

Ideal for the quick and easy cleaning of floors and surfaces. Robust and user-friendly design.

- 360° rotating, 4 smooth wheels
- Black, robust plastic frame
- 2 x 20-liter plastic buckets in black with handles in blue and red
- 2 x 8-liter plastic buckets in black with handles in blue and red
- 1 x plastic press in black
- Waste/laundry bag with lid and zipper, including side pocket
- Side tray for mop holder

Size	Item No.	Unit
750 x 680 x 1140 mm	EB100RC	1 Set



**Gross Weight: 16,80 kg**  
**Net Weight: 14,80 kg**



### TOOLS HOLDER

#### ACCESSORY HOLDER

Holder for handles with two additional hanging hooks. Practical, stable, and space-saving.

- 400 mm: Suitable for up to 5 devices
- 520 mm: Suitable for up to 6 devices

Size	Item No.	Unit
400 mm	TH400	1 pcs.
520 mm	TH520	



**ECOBLOCK S9Q**

**VACUUM CLEANER MADE FROM RECYCLED PLASTIC**

Dry vacuum cleaner, made of recycled materials, has been specially designed for professional use and application in the building cleaning.



- Sturdy construction, tilt resistant
- Made from recycled materials from battery cases
- Easy handling
- Accessory storage on the device
- Parking position for floor nozzle
- 5-fold filtered → long life of the motor
- Includes floor nozzle, crevice nozzle short & long, upholstery nozzle, Cartridge filter, suction tube, suction hose and fleece filter bag

Size   Weight	Item No.	Unit
33 x 40 x 40 cm   7 kg	EBS9Q	1 Set
<b>Power Supply</b>	220/240 V / 50/60 Hz	
<b>Power</b>	1250 W	
<b>Volume</b>	12 l	
<b>Water Column</b>	2500 mmH <sub>2</sub> O	
<b>Air Flow</b>	35 l/s	
<b>Cable Length</b>	10 m	
<b>Noise Level</b>	68 dB	



**INCLUDED IN SET**

			
FLOOR NOZZLE	UPHOLSTERY NOZZLE	CREVICE NOZZLE LONG	CREVICE NOZZLE SHORT
			
CARTRIDGE FILTER	SAUGH HOSE	SUCTION TUBE	FLEECE FILTER BAG



**ECOBLOCK S9Q FLEECE FILTER BAG 3-LAYERS**

**WHITE**

Tear-resistant fleece filter bags 3-layers with optimal dirt absorption.

Item No.	Unit
S9Q-VFT	15x10 pcs.

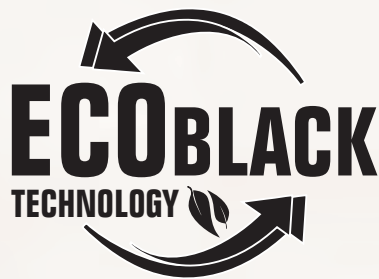

## PRO1PLUS

### PROFESSIONAL COMMERCIAL VACUUM CLEANER WITH COOLING SYSTEM

Specially designed for use in building cleaning, suitable for various types of surfaces, from carpets to laminate floors, ideal for daily maintenance cleaning.

- Sturdy construction thanks to impact-resistant materials
- With power switch (750 and 1200 W)
- Rubberized wheels, as well as wall and furniture protection strip
- Exhaust filter cartridge for cleaning the exhaust air
- Secondary air valve for motor cooling
- With a large, convenient handle for easy and secure transport
- On-device accessory storage
- Parking position for the floor nozzle
- Orange power cable with a secure plug system reduces the risk of tripping hazards
- Includes floor nozzle, suction hose, 2-piece metal suction tube, crevice nozzle, upholstery nozzle, brush nozzle, and fleece filter bag

Size   Weight	Item No.	Unit
35 x 42 x 32 cm   7 kg	PRO1PLUS	1 Set

<b>Power Supply</b>	230 V / 50 Hz
<b>Power</b>	750 W / 1200 W
<b>Volume</b>	10 l
<b>Air Flow</b>	53 l/s
<b>Vacuum</b>	27 / 29 kPa
<b>EPA filter</b>	EPA10/HEPA13
<b>Working range</b>	19 m
<b>Suction hose length</b>	2,8 m
<b>Cable Length</b>	15 m
<b>Noise Level</b>	67 dB



### PRO1PLUS FLEECE FILTER BAG 3-LAYERS

#### WHITE

Tear-resistant 3-ply fleece filter bags with optimal dirt absorption.

Item No.	Unit
01313	15x10 pcs.



### PRO1PLUS TEXTILE FILTER BAG

#### REUSABLE

Reusable textile permanent fabric filter with optimal dirt absorption.

Item No.	Unit
OH-077	1 pcs.

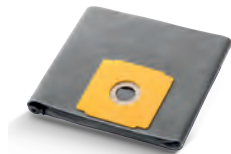

### MAGIC SUCTION NOZZLE

#### UNIVERSAL FOR ALL VACUUM CLEANERS

Suitable for cleaning and removing dust mites from all textile surfaces.

- Vibrating suction allows for the removal of dirt, dust, mites, etc.
- Suitable for any standard vacuum cleaner

Item No.	Unit
01271	1 pcs.



### PRO1PLUS TURBO NOZZLE

#### WITH BRUSH ROLL

The turbo nozzle ensures deep cleaning during carpet cleaning thanks to the integrated brush roll. Embedded dirt is removed from the carpet, and the brush roll additionally lifts the carpet pile.

Item No.	Unit
TB-P1-M5	1 pcs.





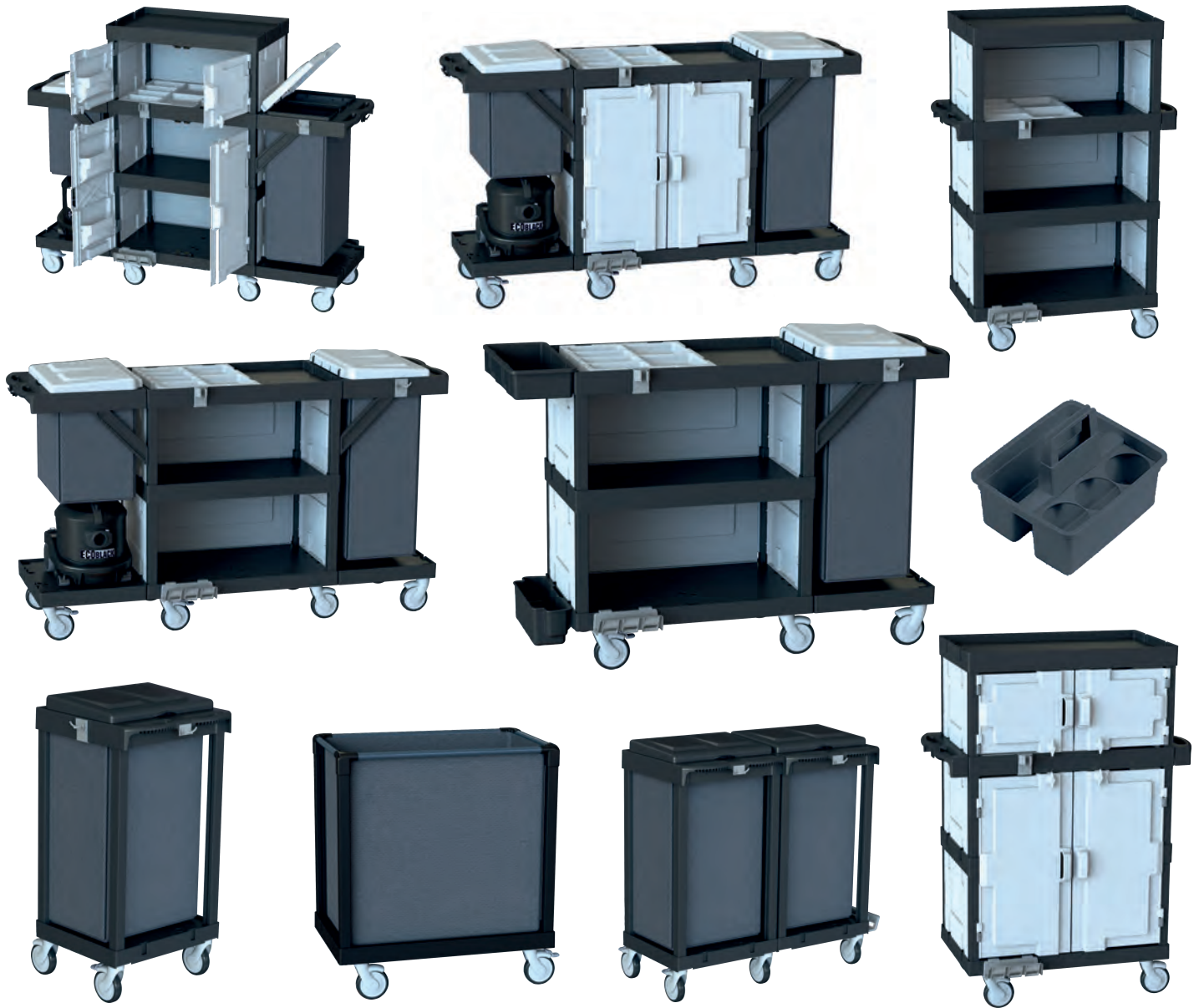

**COMING SOON!**





# KITCHEN HYGIENE





## INPUR®

pH 11,4

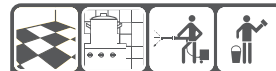

### ALKALINE DEGREASER / POWERFUL KITCHEN CLEANER

Effectively cleans protein- and oil-contaminated alkaline-resistant surfaces of all kinds. Ideal for cleaning in food processing facilities.

- Low foaming, suitable for mechanical use, compatible with high-pressure devices
- Especially for cleaning heavily grease-soiled floors, countertops, and exhaust hoods

Container	Item No.	Unit
1 l Bottle	01021	12x1 l
10 l Canister	01018	1x10 l



## FAT-CLEAN RTU

pH 12-13



### READY-TO-USE POWERFUL KITCHEN CLEANER

Effectively cleans grease, protein, and oil-contaminated alkaline-resistant surfaces of all kinds. Especially suitable for cleaning heavily grease-soiled surfaces and exhaust hoods. Ideal for daily cleaning.

- Optimal for cleaning in food processing facilities
- 500 ml spray bottle with a convenient spray head

Container	Item No.	Unit
500 ml Bottle	01022	20x500 ml
10 l Canister	01016	1x10 l



## CHLORADO®

pH 12,5



### KITCHEN CLEANER WITH ACTIVE CHLORINE

Highly concentrated kitchen degreaser with active chlorine for removing plant and animal fats, oils, blood, protein, and mold. Kills all bacteria, fungi, and viruses. HACCP-approved for the food industry.

- Strong bleaching effect on tea, coffee, fruit, and mildew stains
- Cleans quickly and ensures hygienic cleanliness in the food industry

Container	Item No.	Unit
10 l Canister	01138	1x10 l



## POWER-CLEAN

pH 14



### GRILL CLEANER AND RESIN REMOVER

Highly concentrated, alkaline intensive cleaner and resin remover that works quickly and autonomously.

- Applicable on warm and cold surfaces
- Dissolves burnt, charred, and encrusted residues
- Can also be used as an intensive grease remover in high dilution

Container	Item No.	Unit
1 l Bottle	01006	12x1 l
10 l Canister	01015	1x10 l



## GRILL-CLEAN RTU

pH 13



### LOW-ODOR HIGH-ALKALINE GRILL CLEANER

Ready-to-use, high-alkaline grill and oven cleaner for the intensive cleaning of alkaline-resistant surfaces. Dissolves heavy soiling such as grease, oil, protein deposits, and roasting residues. LOW-ODOR grill cleaner with high grease-dissolving power.

- Fast-acting, foaming cleaner
- 500 ml spray bottle with a convenient spray head

Container	Item No.	Unit
500 ml Bottle	01061	20x500 ml
10 l Canister	01017	1x10 l







## ORKAN

pH 9,7



### COLD STORAGE CLEANER UP TO -30°C

Special cleaner for surfaces up to -30°C. Removes oily and greasy dirt, effectively cleaning heavily soiled floors.

- Hygienically clean effect
- No need for defrosting the cold storage

Container	Item No.	Unit
10 l Canister	01089	1x10 l



## EDOL 2IN1 RTU

pH 5



### STAINLESS STEEL CLEANER AND CARE IN ONE

Ready-to-use stainless steel cleaner and care product for all aluminum, anodized, stainless steel, and non-ferrous metal surfaces. Leaves a protective film. Restores the original shine to cleaned surfaces

- Removes deposits on surfaces and appliances, as well as fingerprints, water stains, and other dirt
- Prevents rapid re-soiling with regular use
- 500 ml spray bottle with a convenient spray head

Container	Item No.	Unit
500 ml Bottle	01071	20x500 ml



## BIO-LIVE®

pH 8,6-8,9



### BIOLOGICAL CLEANER AND ODOR ELIMINATOR

Eliminates even stubborn odors in, for example, trash bins, toilets, washrooms, laundry depots, etc. The included cultures (live microorganisms) also break down deeply penetrated dirt and stains, eliminating bad odors.

- Also suitable for treating stains on carpets, fabrics, tablecloths, and bed linens, leaving a long-lasting pleasant fragrance

Container	Item No.	Unit
1 l Bottle	01096	12x1 l
5 l Canister	01082-05	1x5 l



## CLEATOR

pH 1,7



### LIME SCALE REMOVER FOR COMMERCIAL MACHINES

Acidic, liquid lime scale remover that removes lime deposits, water stains, and other residues on the inner surfaces of machines.

- For hot water devices, dishwashers, coffee machines, washing machines, and similar appliances

Container	Item No.	Unit
1 l Bottle	01165	12x1 l
10 l Canister	01185	1x10 l



## CITRUS POWER

pH 7



### PREMIUM HAND DISH SOAP WITH CITRUS POWER

Skin-friendly, neutral, surfactant-containing dish soap with a pleasant **citrus fragrance**. Suitable for the gentle cleaning of all waterproof surfaces. Optimal grease and dirt dissolving power.

- For sparkling clean, shiny dishes
- Gentle on hands, pH-neutral
- Good flowability for a brilliant shine without drying



Container	Item No.	Unit
1 l Bottle	01183	12x1 l
10 l Canister	01178	1x10 l



## PROTAP 2IN1

pH 10



### DISHWASHING CONCENTRATE AS TAB

Highly concentrated dishwasher tabs with integrated rinse aid component for commercial and household dishwashers.

- Cleans and rinses in one with 2-phase tabs
- Removes stubborn and dried-on dirt while being gentle on glass and decor
- Rinse aid prevents water spots and ensures a radiant shine

Container	Item No.	Unit
60 Tabs in Box	01163	5x60 Tabs
180 Tabs Bucket	01161	180 Tabs





## ECO PLUS

pH 13



### DISHWASHER DETERGENT FOR DISHWASHERS

Powerful and reliable dishwashing and degreasing agent for the machine cleaning of dishes and kitchen utensils in the food industry and kitchen facilities with liquid dosing pumps.

- Alkaline cleaner with good starch-dissolving action and chlorine content
- Specially designed for use in commercial dishwashers with automatic dosing

Container	Item No.	Unit
12 kg Canister	01179	1x12 kg



## ECO PLUS-CF

pH 11,8



### CHLORINE-FREE DISHWASHER DETERGENT

Powerful, environmentally friendly dishwashing detergent without chlorine for the machine cleaning of dishes and kitchen utensils in the food industry and kitchen facilities.

- Alkaline cleaner with good starch-dissolving action, chlorine-free
- Gently cleans dishes, glasses, cutlery, etc.

Container	Item No.	Unit
12 kg Canister	01306	1x12 kg



## ECO-GLS

pH 11,9



### GLASSWARE DETERGENT FOR DISHWASHERS

Liquid machine detergent for glass dishwashers. Concentrated and chlorine-free glassware detergent with increased cleaning performance.

- Removes crusts and heavy greasy dirt
- Specifically designed for commercial glass dishwashers with automatic liquid dosing, chlorine-free

Container	Item No.	Unit
12 kg Canister	01181	1x12 kg



## WD 36 P

### WET/DRY VACUUM CLEANER WITH 36 LITER TANK VOLUME

Ideally suited for hotels, building cleaners, schools, industrial and craft businesses, as well as public buildings and authorities.

- Highly efficient, powerful motor
- Accessory holder
- Exhaust filter for versatile use
- Automatic float shutdown for a long lifespan
- Includes dry floor nozzle, water nozzle, brush nozzle, crevice nozzle, upholstery nozzle, textile filter, suction tube, suction hose

Size   Weight	Item No.	Unit
50x 38 x 68,5 cm   9,6 kg	WD36P	1 Set

<b>Max. Power Consumption</b>	1250 W
<b>Container Capacity</b>	36 l
<b>Actual Capacity</b>	25 l
<b>Water Column</b>	235 mbar
<b>Airflow</b>	71 l / s
<b>Cable Length</b>	10 m
<b>Noise Level</b>	60 dB







## EXCELLENT ABRASIVE MOP DB-FC GREY-WHITE

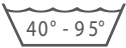

### WITH COVER SHEET

Ideal for the maintenance and deep cleaning of hard floor surfaces and porous stone floors. Not suitable for coated floors.

- Strong scrubbing action for dirt and stain removal
- Optimal dirt-dissolving power thanks to abrasive polyamide bristle strips
- Ideal for stubborn dirt
- Suitable for non-slip and safety floors

Size   Weight	Item No.	Unit
40 cm   ca. 120 g	EAMF40DBFC	75 pcs.
50 cm   ca. 140 g	EAMF50DBFC	50 pcs.

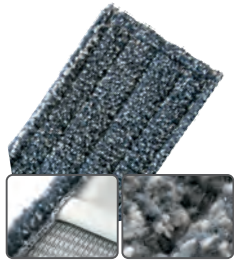

## EXCELLENT SCRUB-IGEL MICROFIBER MOP

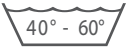

### WITHOUT COVER SHEET

Perfect for the maintenance and deep cleaning of hard floor coverings and porous stone floor. Not suitable for uncoated floors.

- Extreme scrubbing feature and dirt absorption
- Hedgehog microfiber mop with polyester bristle monofilaments
- Ideal against stubborn dirt
- Optimally suitable for non-slip floors and safety floors

Size   Weight	Item No.	Unit
40 cm   ca. 80 g	ESMMF40	75 pcs.
50 cm   ca. 110 g	ESMMF50	50 pcs.

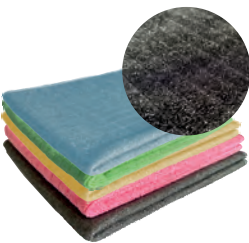

## SCRUB & CLEAN 2IN1 MICROFIBER CLOTH

Alternative to cleaning sponge!

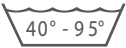

### BLUE/GREEN/YELLOW/PINK/GREY

The cloth is ideal for stubborn dirt and crust, especially in the kitchen and bathroom.

- With abrasive bristle side and soft microfiber side
- Excellent dirt-dissolving power thanks to the abrasive bristle side
- High dirt and water absorption thanks to the microfiber side
- For thorough and scratch-free cleaning on surfaces

Size   Weight	Item No.	Unit
40 x 40 cm   ca. 45 g/cloth	ASC4040BL	30x5 pcs.
	ASC4040GR	
	ASC4040GE	
	ASC4040RO	
	ASC4040GU	



## GLASS-SHINE MICROFIBER GLASS POLISH CLOTH

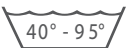

### WHITE

This microfiber cloth is ideal for polishing and cleaning glasses. Perfect for use in hotels, restaurants, and bars (HoReCa).

- Cleans lint-free and streak-free, leaving shiny surfaces
- Maximum dirt and water absorption capacity
- Also suitable for dishes and cutlery

Size   Weight	Item No.	Unit
50 x 80 cm   ca. 64 g/cloth	AGP5080TU	1 pcs.



## MULTI-SHINE MICROFIBER DISH TOWEL

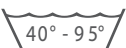

### BLUE

For a lint-free and grease-absorbing cleaning on all smooth surfaces. Made of a very fine and durable material.

- Double stitched edge protection and additional quality binding tape
- Maximum absorption power of dirt and water
- Universally applicable

Size   Weight	Item No.	Unit
50 x 60 cm   ca. 52 g/cloth	AGS5060BL	15x10 pcs.





## ARCORA® COPPER PRODUCTS

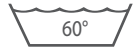

### COPPER SPONGE AND COPPER CLOTH

Concrete residue, graffiti, lime, adhesive residues, hairspray, and silicones? No problem for copper products. They ensure gentle cleaning of pots, sinks, faucets, pans, enamel, glass, mirrors, ceramic hobs, stainless steel, and non-painted metal parts. Even rust spots on cutlery can be removed.

- Only water is needed for cleaning
- Scratch-free application
- Reusable multiple times, washable at 60°C
- Antibacterial

Product	Size   Weight	Item No.	Unit
Copper Sponge	13 x 9 x 2,8 cm   ca. 22 g	01240	100 pcs.
Large Copper Cloth	16 x 19 cm   ca. 25 g	01238	
Small Copper Cloth	10 x 14 cm   ca. 9 g	01239	
Loose Copper Cloth	25 x 25 cm   ca. 34 g	01241	



## PROFI GRIP CLEANING SPONGE

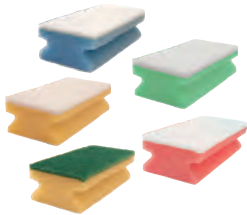

### BLUE-WHITE/GREEN-WHITE/YELLOW-GREEN/YELLOW-WHITE/PINK-WHITE

Durable handle non-woven sponges are ideal for sensitive surfaces. For thorough and scratch-free cleaning.

- High water absorption
- With grip groove to protect hands and fingernails

Size   Weight	Item No.	Unit
150 x 70 x 45 mm   ca. 13 g/Sponge	01141BLW	10x10 pcs.
	01144GRW	
	01145GEG	
	01143GEW	
	01142ROW	



## PU-PAD SPONGE

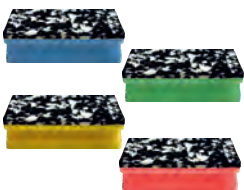

### BLUE/GREEN/YELLOW/RED

Durable sponge with PU back for damp and wet cleaning of insensitive surfaces. The sponge is ideal for use in the kitchen area, removing stubborn dirt.

- Particularly robust and high water absorption

Size   Weight	Item No.	Unit
150 x 70 x 45 mm   ca. 17 g/Sponge	PU15070BL	28 pcs.
	PU15070GR	
	PU15070GE	
	PU15070RO	



## METAL POT CLEANER



40 g

This pot cleaner is ideal for removing stubborn dirt. It cleans gently, effectively, and without scratches.

- Cleans powerfully and hygienically
- Rust-free and very durable



Weight	Item No.	Unit
ca. 40 g	01194	40x10 pcs.

## STAINLESS STEEL SPIRAL POT CLEANER



40 g

For the removal of limescale and dirt deposits in the kitchen area. It cleans gently, effectively, and without scratches.

- Cleans powerfully and hygienically
- Rust-free and durable



Weight	Item No.	Unit
ca. 40 g	01195	10x10 pcs.



# PUBLIC AREA





### TERMINATOR® RTU

#### READY-TO-USE POWER SPRAY CLEANER

Removes stubborn dirt on washable surfaces.

- Powerful spray cleaner
- Eliminates grease, oil, ink, and pen residues, lipstick, scuff marks, tire tracks, and smoke deposits
- Ideal for cleaning glass frames
- 500 ml spray bottle with practical spray nozzle

pH 12

Container	Item No.	Unit
500 ml Bottle	01223	20x500 ml
5 l Canister	01224	1x5 l



### IDEAL

#### ALKALINE PORCELAIN TILE CLEANER

Special cleaning concentrate for porcelain tiles and safety tiles. Can be used as a basic cleaner as well as for regular maintenance cleaning.

- Effortlessly dissolves stubborn, oily, and greasy dirt
- Cleans deeply, thoroughly, and intensively
- **EDTA-free**

pH 9,5

Container	Item No.	Unit
1 l Bottle	01153	12x1 l
10 l Canister	01154	1x10 l



### SCHACHMATT® RTU

#### PLASTIC AND DESK CLEANER

Ready-to-use, highly effective spray cleaner that effortlessly removes water-resistant marker and ballpoint pen residues, grease and oil stains, adhesive, and label residues.

- Suitable for water- and solvent-resistant surfaces
- Cleans streak-free and residue-free
- 500 ml spray bottle with practical spray nozzle

pH 6

Container	Item No.	Unit
500 ml Bottle	01300	20x500 ml
10 l Canister	01092	1x10 l



### CITRUS® *Fresh*

#### NEUTRAL CLEANER

Highly concentrated, universally applicable maintenance cleaner for streak-free cleaning of hard, water-resistant surfaces and floors such as plastics, painted surfaces, glass, mirrors, ceramics, and stainless steel.

- Leaves a radiant shine and a pleasant **citrus scent**
- Dries quickly and streak-free
- Highly concentrated, hence very economical

pH 7

Container	Item No.	Unit
1 l Bottle	01055	12x1 l
10 l Canister	01060	1x10 l



### PURPLE *Fresh*

#### NEUTRAL CLEANER

Highly concentrated, universally applicable maintenance cleaner for streak-free cleaning of hard, water-resistant surfaces and floors, such as plastics, painted surfaces, glass, mirrors, ceramic, stainless steel.

- Leaves a radiant shine and a pleasant **berry scent**
- Dries quickly and streak-free
- Highly concentrated, therefore very economical

pH 7

Container	Item No.	Unit
1 l Bottle	01217	12x1 l
10 l Canister	01218	1x10 l



### ORANGE *Fresh*

#### NEUTRAL CLEANER

Highly concentrated, universally applicable maintenance cleaner for streak-free cleaning of hard, water-resistant surfaces and floors, such as plastics, painted surfaces, glass, mirrors, ceramic, stainless steel.

- Leaves a radiant shine and a pleasant **orange scent**
- Dries quickly and streak-free
- Highly concentrated, therefore very economical

pH 7

Container	Item No.	Unit
1 l Bottle	01345	12x1 l
10 l Canister	01344	1x10 l







**FLEXAL®**

pH 9,5



**POWERFUL MULTI-PURPOSE CLEANER**

Highly active, multifunctional cleaner with excellent power for streak-free cleaning of PU-coated, coated, and uncoated floor coverings. Ideal for cleaning highly water-repellent floor coverings. Low in surfactants and quick-drying.

- High dirt-carrying capacity and excellent wetting properties
- Can replace alcohol, all-purpose, automatic, and neutral cleaners

Container	Item No.	Unit
1 l Bottle	01038	12x1 l
10 l Canister	01037	1x10 l



**SO-KLAR RTU**

pH 10,5



**READY-TO-USE GLASS AND PLASTIC CLEANER**

Ready-to-use cleaner with a fresh summer scent for streak-free cleaning. Effortlessly removes dirt deposits, grease, and oil from glossy surfaces such as windows, glass, mirrors, plastic, frames, and automotive windows.

- **SPRAY - WIPE ONCE - DONE!**
- Cleans quickly, residue-free, and streak-free
- For radiant shine and cleanliness
- Gentle on skin and materials
- 500 ml spray bottle with a convenient spray head

Container	Item No.	Unit
500 ml Bottle	01035	20x500 ml
1 l Bottle	01024	12x1 l
10 l Canister	01023	1x10 l



**WINDOW-CLEAN**

pH 6,5-7,2



**PROFESSIONAL WINDOW CLEANER SOAP**

For fast, thorough, and large-scale cleaning of glass surfaces and window frames. Suitable for both indoor and outdoor use, even at low temperatures.

- Skin-friendly and environmentally friendly
- Powerful concentrate, very economical
- Cleans streak-free and residue-free
- Specially formulated for professional window cleaning

Container	Item No.	Unit
1 l Bottle	01075	12x1 l
5 l Canister	01076	1x5 l





**NEUTRA7**

pH 7-7,5



**NEUTRAL SANITARY ODOR CLEANER FOR MAINTENANCE CLEANING**

Sanitary odor cleaner with a long-lasting and deodorizing fresh scent and patented Neofresh technology.

- Quickly removes skin oils, cosmetic residues, soap residues, limescale, organic dirt, water spots, etc.
- Dries streak-free without the need for additional drying due to the beading effect

Container	Item No.	Unit
1 l Bottle	01157	12x1 l
10 l Canister	01158	1x10 l



**KARMA® Pearl**

pH 1,5



**SANITARY MAINTENANCE CLEANER WITH PEARL EFFECT**

Sanitary maintenance cleaner for daily cleaning in the entire wet area. Dissolves limescale, uric acid, soap, oil, and grease residues. The pearl effect reduces re-soiling and deposits on surfaces.

- Enhancement through polymer surface-active substances (beading effect)
- Streak-free, fast-drying, highly glossy, and protected surfaces
- Maintenance cleaning is significantly facilitated, reducing cleaning time

Container	Item No.	Unit
1 l Bottle	01019	12x1 l
10 l Canister	01002	1x10 l



**BIO-LIVE®**

pH 8,6-8,9



**BIOLOGICAL CLEANER AND ODOR ELIMINATOR**

Eliminates even stubborn odors in, for example, trash bins, toilets, washrooms, laundry depots, etc. The included cultures (live microorganisms) also break down deeply penetrated dirt and stains, eliminating bad odors.

- Also suitable for treating stains on carpets, fabrics, tablecloths, and bed linens, leaving a long-lasting pleasant fragrance

Container	Item No.	Unit
1 l Bottle	01096	12x1 l
5 l Canister	01082-05	1x5 l



**MICRO BLUE 2.0-FC**

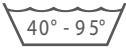

**WITHOUT COVER SHEET**

The dirt wonder among mop covers. Optimal for maintenance cleaning, wet and dry cleaning of elastic coverings, hard floors, laminate floors, as well as smooth and porous floor coverings. Particularly suitable for use in healthcare.

- Improved mechanics and optimal cross-linking of the cleaning solution on the floor due to the tightly woven microfiber yarn
- The yarn composition ensures excellent dirt and water absorption as well as higher surface performance

Size   Weight	Item No.	Unit
40 cm   ca. 85 g	AEMB40FC	75 pcs.
50 cm   ca. 120 g	AEMB50FC	50 pcs.



**EXCELLENT ABRASIVE MOP DB-FC GREY-WHITE**

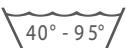

**WITH COVER SHEET**

Optimal for maintenance and basic cleaning of hard floor coverings and porous stone floors. Not suitable for coated floors.

- Strong scrubbing action for dirt and stain removal
- Optimal dirt-solving power thanks to abrasive polyamide bristle strips
- Ideal for stubborn dirt
- Suitable for non-slip floors and safety floors

Size   Weight	Item No.	Unit
40 cm   ca. 120 g	EAMF40DBFC	75 pcs.
50 cm   ca. 140 g	EAMF50DBFC	50 pcs.



**WARNING SIGN PENGUIN**

**YELLOW/WARNING SLIPPERY SURFACE**

- Robust plastic design in signal yellow
- Set up without having to bend down
- Tilt- and break-proof

Size	Item No.	Unit
320 x 680 mm	WSPNG-EN	11 pcs.



### TOP-LINE MICROFIBER CLOTH

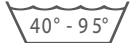

#### BLUE/GREEN/YELLOW/PINK/GREY

The cloth for maintenance cleaning of sensitive surfaces without scratching them. Effortlessly removing of grease stains, fingerprints, dust which ensuring clean, streak-free surfaces.

- Double-stitched edge protection and additional quality edging tape
- Above-average lifespan
- Maximum absorption capacity for dirt and water

Size   Weight	Item No.	Unit
40 x 40 cm   ca. 50 g/cloth	ATL4040BL	20x10 pcs.
	ATL4040GR	
	ATL4040GE	
	ATL4040RO	
	ATL4040SC	



### SCRUB & CLEAN 2IN1 MICROFIBER CLOTH

Alternative to cleaning sponge!

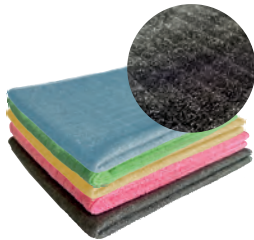
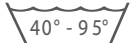

#### BLUE/GREEN/YELLOW/PINK/GREY

The cloth is ideal for stubborn dirt and crust, especially in the kitchen and bathroom.

- With abrasive bristle side and soft microfiber side
- Excellent dirt-dissolving power thanks to the abrasive bristle side
- High dirt and water absorption thanks to the microfiber side
- For thorough and scratch-free cleaning on surfaces

Size   Weight	Item No.	Unit
40 x 40 cm   ca. 45 g/cloth	ASC4040BL	30x5 pcs.
	ASC4040GR	
	ASC4040GE	
	ASC4040RO	
	ASC4040GU	



### FINE-LINE MICROFIBER GLASS CLOTH

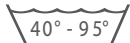

#### BLUE

"A must for glass cleaning." This cloth enables streak-free and lint-free cleaning of glass, mirrors, and chrome.

- Double-stitched edge protection, additional quality edging tape
- Average lifetime
- Maximum absorption capacity for dirt and water
- Super-absorbent: Absorbs 8 times its weight in liquid

Size   Weight	Item No.	Unit
40 x 40 cm   ca. 52 g/cloth	AFL4040BL	20x10 pcs.



### GLASS-SHINE MICROFIBER GLASS POLISH CLOTH

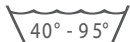

#### WHITE

This microfiber cloth is ideal for polishing and cleaning glasses. Perfect for use in hotels, restaurants, and bars (HoReCa).

- Cleans lint-free and streak-free, leaving shiny surfaces
- Maximum dirt and water absorption capacity
- Also suitable for dishes and cutlery

Size   Weight	Item No.	Unit
50 x 80 cm   ca. 64 g/cloth	AGP5080TU	1 pcs.



### PU-PAD SPONGE

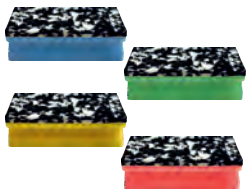

#### BLUE/GREEN/YELLOW/RED

Durable sponge with PU back for damp and wet cleaning of insensitive surfaces. The sponge is ideal for use in the kitchen area, removing stubborn dirt.

- Particularly robust and high water absorption

Size   Weight	Item No.	Unit
150 x 70 x 45 mm   ca. 17 g/Sponge	PU15070BL	28 pcs.
	PU15070GR	
	PU15070GE	
	PU15070RO	



### SWEEPING SET DELUXE



#### TURQUOISE-DARK GREY

Robust dustpan set with broom and foldable dustpan including a clip. For cleaning floors without bending over. The dustpan opens upon contact with the floor and closes when lifted.

- Bristles pick up the finest dust and dirt
- Practical holder on the handle ensures space-saving and easy storage of the dustpan set
- With an integrated eyelet for hanging

Size	Item No.	Unit
245 x 280 x 1000 mm	KS8DLX	8 pcs.





## ECOBLOCK 750

### SERVICE TROLLEY

Ideal for quick and easy cleaning of floors and surfaces. Robust and user-friendly design.

- 360° rotatable, 6 smooth-rolling wheels
- Black, sturdy plastic frame
- 2 x 20-liter black plastic buckets with handles in blue and red
- 4 x 6-liter black plastic buckets with handles in blue, green, yellow, red in the cabinet with manually lockable lid, including a shelf for a work plan
- 1x black plastic press
- 1x black plastic tray, 1x black plastic box without lid
- With sturdy plastic doors, manually lockable
- Lockable cabinet with waste/laundry bag and lid
- Black plastic tray below the waste/laundry bag
- Side shelf for mop holder

Size	Item No.	Unit
1410 x 680 x 1100 mm	EB750RC	1 Set



**Gross Weight: 40,30 kg**  
**Net Weight: 37,80 kg**

## BORA MEDICAL 750

### HYGIENE TROLLEY

The hygiene cart with a closed system is specifically designed for cleaning in the healthcare sector. It impresses with stability and user-friendliness.

- Black, robust plastic frame made from recycled materials
- 360° rotatable, 6 smooth-rolling wheels
- 2 x 20-liter gray plastic buckets with handles in blue and red
- 4 x 6-liter gray plastic buckets with sieve for cloth preparation with handles in blue, green, yellow, red in the cabinet with manually lockable lid, including a shelf for a work plan
- 1x turquoise-gray plastic press
- 1x gray plastic tray, 1x gray plastic box with turquoise lid
- With sturdy plastic doors, manually lockable (key)
- Waste/laundry bag with lid in a second lockable cabinet
- Side shelf for mop holder

Size	Item No.	Unit
1415 x 600 x 1115 mm	B750MD	1 Set



**Gross Weight: 41,00 kg**  
**Net Weight: 39,00 kg**

## TOOLS HOLDER

### ACCESSORY HOLDER

Holder for handles with two additional hanging hooks. Practical, stable, and space-saving.

- 400 mm: Suitable for up to 5 devices
- 520 mm: Suitable for up to 6 devices

Size	Item No.	Unit
400 mm	TH400	1 pcs.
520 mm	TH520	





## ARCORA® 510BM/50L

### SCRUBBER DRYER MACHINE

The manually operated floor scrubber dryer is ideal for both basic and routine cleaning, especially in heavily frequented areas such as shopping centers, supermarkets, offices, and public facilities. It is characterized by flexibility, user-friendliness, and excellent cleaning performance. Thanks to the large brush diameter, large surfaces are reliably and quickly cleaned without leaving residues.

- Easy handling, ergonomic design
- Optimal cleaning performance
- Robust construction
- Easy brush and drive disc replacement
- High maneuverability
- Includes on-board charger, batteries, pad holder, scrub brush



	Weight	Item No.	Unit
	75 kg / 135 kg (w. battery)	SCR510BM	1 Set
<b>Brush Diameter</b>	510 mm		
<b>Suction Width</b>	760 mm		
<b>Battery</b>	2 x DC12V 100 AH		
<b>Brush Motor</b>	550 W		
<b>Cleaning Performance</b>	2000 m <sup>2</sup> /h		
<b>Water Tank</b>	47-50 Lt		
<b>Brush RPM</b>	150 rpm		
<b>Brush Pressure</b>	30 kg		
<b>Max. Vacuum</b>	180 mbar		
<b>Operating Time</b>	3 h		





## ARCORA® RO-MAN 660BR/90L

### RIDE-ON SCRUBBER DRYER MACHINE

The battery-operated compact ride-on scrubber dryer RO-MAN 660BR/90L efficiently and comfortably cleans medium to large surfaces quickly and residue-free. With high cleaning performance using 2 brushes or 2 drive discs and ergonomic controls, effortless and user-friendly cleaning is ensured.



Weight	Item No.	Unit
262 kg	SCR660BR	1 Set

<b>Rated Voltage</b>	2 x 12 V (24 V) 150 Ah
<b>Working Width</b>	660 mm/ 2 x 330 mm (2 x 13")
<b>Brush Motor</b>	2 x 400 W
<b>Brush Rotation Speed</b>	180 U/min
<b>Suction Motor</b>	450 W
<b>Pump Pressure</b>	160 mbar
<b>Drive Motor</b>	500 W
<b>Speed</b>	0-7 km/h
<b>Fresh Water Tank</b>	90 L
<b>Dirty Water Tank</b>	100 L
<b>Cleaning Performance</b>	ca. 3800 m <sup>2</sup> /h
<b>Runtime / Charging Time</b>	180 min / 8 h
<b>Suction Width</b>	1000 mm
<b>Weight with Batteries</b>	262 kg
<b>Dimensions</b>	140 x 75 x 139 cm



Simple operation and a mechanical design contribute to reliable and long-lasting performance. With a maximum speed of 7 km/h, the pace can be adjusted according to the environment and level of dirt. A 90-liter fresh water tank and a 100-liter dirty water tank enable the cleaning of large areas.

- Compact and robust ride-on machine
- High maneuverability, ideal for tighter spaces
- Ergonomic design
- Quiet operation
- Easy brush and drive disc replacement
- Excellent suction results
- Includes batteries, integrated charger, 2 x drive discs, 2 x scrub brushes

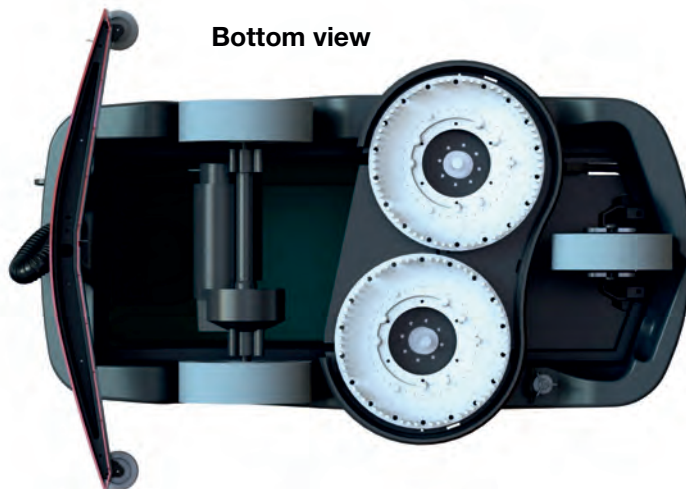

# SPECIAL CLEANING







## PALACE LIQ

pH 8



### SPECIAL CLEANER FOR NATURAL AND ARTIFICIAL STONE

Contains highly active cleaning agents that clean and nourish quickly and thoroughly. The natural care components optimize the color and structure of the surface, giving it a brilliant appearance.

- Can be applied manually and mechanically
- Special cleaner for all floor, stair, and wall coverings made of natural and artificial stone
- Universally applicable to all water-resistant surfaces
- Self-polishing and does not build up layers

Container	Item No.	Unit
1 l Bottle	01290	12x1 l
5 l Canister	01291	1x5 l



## HAMMER®

pH 12



### DIRT BREAKER/HIGH-PERFORMANCE CLEANER

Alkaline high-performance cleaner for all alkali- and water-resistant floor coverings.

- Powerful, low-foaming cleaner based on special active ingredients
- Suitable for all machine methods
- Dissolves machine oil, fats, soot, graphite, and exhaust deposits

Container	Item No.	Unit
10 l Canister	01041	1x10 l



## EXBETAN-X

pH 11,3



### WORKSHOP AND INDUSTRIAL CLEANER

Highly concentrated special cleaner for heavy soiling on alkali- and water-resistant materials in workshops, automotive, and commercial vehicle areas. Cleans quickly, effortlessly, and gently on materials.

- Thoroughly removes grease and oil stains, soot, and stubborn dirt crusts
- Oil separator-friendly according to **Ö-NORM B 5105** and **EDTA-free**

Container	Item No.	Unit
10 l Canister	01025	1x10 l



## MOSS & ALGAE REMOVER LIQUID

pH >11



### FOR REMOVING ORGANIC CONTAMINANTS ON STONES

Highly effective moss, algae, and green growth remover that deeply and thoroughly cleans any dirt on mineral building materials such as natural stone, sand-lime brick, plaster, brick, concrete, and fiber cement. Organic dirt is removed in a self-cleaning process.

- Surfaces are deeply and long-lastingly protected against recontamination

Container	Item No.	Unit
1 l Bottle	01288	12x1 l



## SANEX

pH <1



### SANITARY DEEP CLEANER

Powerful cleaner for final construction cleaning, cement stain removal and removal of residues on stainless steel surfaces. High-performance deep cleaner for the removal of lime deposits, rust stains, urine and other residues on acid-resistant surfaces. With integrated corrosion inhibitor.

- Acidic deep cleaner, based on phosphoric acid
- Gentle on materials and free of hydrochloric acid

Container	Item No.	Unit
1 l Bottle	01020	12x1 l
10 l Canister	01003	1x10 l



## SALPUREX 3IN1

pH 1



### URINE/LIMESTONE REMOVER AND CEMENT RESIDUE REMOVER

Acidic high-performance deep cleaner for use on all acid-resistant surfaces in outdoor and indoor pools and other wet room areas.

- Removes old and lime deposits, rust stains, urine scale, other residues, spontaneously effective
- Powerful cleaner for construction cleaning and cement residue removal
- Radical cleaner based on hydrochloric acid Corrosion protection through inhibitor

Container	Item No.	Unit
1 l Bottle	01155	12x1 l
10 l Canister	01137	1x10 l





### GROUT CLEANER RTU

pH 2,1



#### PROFESSIONAL GROUT CLEANER

Ready-to-use, acidic special cleaner for all cement, mineral, and silicone grout.

- Effortlessly removes organic impurities, grease, soap, and care product residues, as well as other dirt deposits
- Ensures bright and hygienically clean wall and floor joints
- 500 ml spray bottle with a convenient spray head

Container	Item No.	Unit
500 ml Bottle	01226	20x500 ml
5 l Canister	01342	1x5 l



### TERMINATOR® RTU

pH 12



#### READY-TO-USE POWER SPRAY CLEANER

Removes stubborn dirt on washable surfaces.

- Powerful spray cleaner
- Eliminates grease, oil, ink, and pen marks, lipstick, scuff marks, tire tracks, and smoke residues
- Ideal for cleaning glass frames
- 500 ml spray bottle with a convenient spray head

Container	Item No.	Unit
500 ml Bottle	01223	20x500 ml
5 l Canister	01224	1x5 l



### TENAS 4IN1

pH 6-7



#### CARPET CLEANER WITH ENCAPSULATION SYSTEM

The system performs the tasks of **five** classic carpet cleaners: Only one product for stain removal, pre-cleaning, extraction cleaning, bonnet cleaning, and the dry cleaning system with the ANIKO 350 DUO BRUSH. Dirt is broken down, bound, and encapsulated.

- Polymers prevent re-soiling and graying
- Shortens drying time, protects carpet fibers
- Saves time, money, and space

Container	Item No.	Unit
1 l Bottle	01008	12x1 l
5 l Canister	01028-05	1x5 l



### TENAS GRANULATE

pH 7



#### CARPET CLEANING GRANULATE WITH ENCAPSULATION SYSTEM

Removal of deep-seated dirt from carpets. The granulate are very skin-friendly. Street dirt, food and beverage stains, including coffee or red wine, as well as oil, fat, shoe polish, etc., are completely removed. Made from plant materials and biodegradable.

- Dry granulate eliminate drying times
- The carpet is immediately walkable
- Leaves no residues or watermarks

Container	Item No.	Unit
1 kg Bag	01261	10x1 kg
10 kg Bucket	01262	1x10 kg



### TENAS HAND BRUSH

TENAS hand brush with foam and bristles for targeted stain removal on upholstery and carpets. With dosing handle for cleaning chemicals. Ideally suited for smaller areas.

- Ideal for cleaning smaller and hard-to-reach areas
- Brushes provide the necessary mechanical friction, and the foam ensures optimal foam distribution

Item No.	Unit
01254	1 pcs.



### POLISH-LINE MICROFIBER CLOTH HIGH-PILE EDGELESS

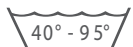

#### BLUE

The fluffy microfiber cloth, thanks to its soft high pile, has a high dirt and water absorption capacity.

- Maximum dirt and water absorption
- Above-average lifespan



Size   Weight	Item No.	Unit
40 x 40 cm   ca. 62 g/cloth	APOL4040BL	20x10 pcs.



**SUNSHINE STRONG PLUS No1+/DARK BROWN**

**STEP 1+**

Application for extremely stubborn dirt to pretreat the flooring.

- Rough, greasy, heavily soiled surfaces
- Occasional use for severe cases

Size	Grit	Item No.	Unit
17"= 432 mm	350	ADP-350DBR	10 pcs.



**SUNSHINE STRONG PLUS No1/RED**

**STEP 1**

Used for high-performance surface restoration. Intended for deep cleaning and as an initial base for the entire process.

- Rough, greasy, heavily soiled surfaces
- Process starter/occasional use

Size	Grit	Item No.	Unit
17"= 432 mm	400	ADP-500RO	10 pcs.

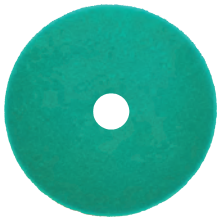

**SUNSHINE MULTI No2/BLUE**

**STEP 2**

Suitable for basic cleaning, creates an economical, light-reflective surface.

- Heavily trafficked floors, dusty areas
- Occasional use for deep cleaning
- Daily use for a light shine

Size	Grit	Item No.	Unit
17"= 432 mm	800	ADP-1000BL	10 pcs.



**SUNSHINE FINE No3/YELLOW**

**STEP 3**

Suitable for daily polishing and cleaning, leaving a clear, reflective shine.

- All floors
- Maintenance of regular polish
- Daily use for a high-gloss polish

Size	Grit	Item No.	Unit
17"= 432 mm	1500	ADP-1500GE	10 pcs.



**SUNSHINE FINAL No4/GREEN**

**STEP 4**

The very fine pad can be used wet or dry and leaves a flawless high-gloss floor. Through daily use, polish is maintained and improved.

- All floors
- Cleaning and polishing
- Daily use

Size	Grit	Item No.	Unit
17"= 432 mm	3000	ADP-3000GR	10 pcs.



**SUNSHINE GOAL No5/OLIVE**

**STEP 5**

The ultra-fine pad ensures an unparalleled and glossy floor. Through daily use, the floor maintains its crystal-clear high gloss.

- All floors
- High-gloss polish
- Daily use for the "Mirror-Shine"

Size	Grit	Item No.	Unit
17"= 432 mm	8000	ADP-8000OL	10 pcs.





### SD 17

#### SINGLE DISC MACHINE INCL. ACCESSORIES

Powerful single disc machine universal and versatile. For intensive cleaning of all floor coverings as well as for light polishing work.

- Robust planetary gear
- Complete accessories for all surfaces
- Integrated 10 liter fresh water tank
- Toolless brush and disc change
- Large rubberized wheels for easy transportation
- Incl. scrubbing brush, carpet cleaning brush, pad holder, fresh water tank

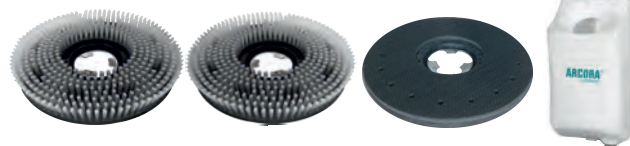

Weight	Item No.	Unit
38 kg	SD17SET	1 Set
<b>Power</b>	1200 W	
<b>Voltage</b>	220-240 V / 50 Hz	
<b>Brush speed</b>	154 rpm	
<b>Diameter brush</b>	17"/ 432 mm	
<b>Diameter pad holder</b>	16-17"	
<b>Fresh water tank</b>	10 Liter	
<b>Cable Length</b>	12 m	

#### INCLUDED IN SET

Product	Item No.	Unit
Scrubbing brush 17"	SD17-FB	1 pcs.
Carpet cleaning brush 17"	SD17-SHB	
Pad holder 17"	SD17-PH	
Fresh water tank 10 l	SD17-10L	

### ORBITAL HEAVY OR17

#### ORBITAL MACHINE

The ORBITAL MACHINE **HEAVY OR17** impresses with its combination of eccentric and rotary motion. The oscillating head adapts to all surfaces and allows for work on uneven floors. The special orbital technology significantly enhances mechanical cleaning power, minimizing the need for other factors. Thanks to orbital technology, the removal of coatings without chemicals becomes easy. The ORBITAL MACHINE **HEAVY OR17** is well-suited for treatments such as polishing, crystallization, micro-sanding of marble, cement, stone, parquet, clay tiles, and stoneware. It is also optimal for cleaning sensitive surfaces such as carpets.

- Robust construction
- User-friendly, fatigue-free operation
- Includes fluid tank, drive pad, locking system



#### Head Locking System



Weight	Item No.	Unit
71,5 kg	OR17SET	1 Set
<b>Power</b>	1300 W	
<b>Voltage</b>	220-240 V / 50 Hz	
<b>Brush/Pad Pressure</b>	48,2 g/cm <sup>2</sup>	
<b>Clearance Height</b>	285 mm	
<b>Revolutions</b>	1500 rpm	
<b>Noise Level</b>	< 54 dB	
<b>Fluid Tank</b>	12 l	
<b>Cable Length</b>	12 m	

### WD 36 P

#### WET/DRY VACUUM CLEANER WITH 36 LITER TANK VOLUME

Ideally suited for hotels, building cleaners, schools, industrial and craft businesses, as well as public buildings and authorities.

- Highly efficient, powerful motor
- Accessory holder
- Exhaust filter for versatile use
- Automatic float shutdown for a long lifespan
- Includes dry floor nozzle, water nozzle, brush nozzle, crevice nozzle, upholstery nozzle, textile filter, suction tube, suction hose



Size   Weight	Item No.	Unit
50x 38 x 68,5 cm   9,6 kg	WD36P	1 Set
<b>Max. Power Consumption</b>	1250 W	
<b>Container Capacity</b>	36 l	
<b>Actual Capacity</b>	25 l	
<b>Water Column</b>	235 mbar	
<b>Airflow</b>	71 l / s	
<b>Cable Length</b>	10 m	
<b>Noise Level</b>	60 dB	



### ANIKO 350 DUO BRUSH

#### ROTARY BRUSH SYSTEM MACHINE

Ideal for cleaning carpets and can also be used on hard floors. With its counter-rotating brush system, this machine is well-suited for daily use, from applying cleaning agents to dirt removal.

- Short drying times and no residues
- Working width of 35.5 cm allows use in tight spaces
- Removal of coarse dirt
- Dry and wet cleaning possible
- Floor scrubbing
- Suitable for use in cleaning companies, hotels, trains, cinemas, bars, hospitals, and public facilities, etc.

#### INCLUDED IN THE SET



Size   Weight	Item No.	Unit
40,5 x 28,5 x 23 cm   21,3 kg	ANIKO350	1 Set
<b>Performance</b>	600 W	
<b>Brush Speed</b>	483 U/min.	
<b>Carpet Cleaning Performance</b>	up to 100 m <sup>2</sup> /h	
<b>Hard Floor Cleaning Performance</b>	up to 200 m <sup>2</sup> /h	
<b>Dirty Water Tank</b>	2,8 l	
<b>Noise Level</b>	57,8 dB	
<b>Cable Length</b>	10 m	

#### SPECIAL ACCESSORIES

Product	Item No.	Unit
Replacement Brush Standard Blue	01266	1 pcs.
Replacement Brush Soft, White	01267	
Replacement Brush Hard, Dark Brown	01268	
Replacement Brush Extra Hard, Black	01269	



### TENAS GRANULATE

#### CARPET CLEANING GRANULATE WITH ENCAPSULATION

Removal of dirt from carpets. The granulate are very skin-friendly. Street dirt, food and beverage stains, including coffee or red wine, as well as oil, fat, shoe polish, etc., are completely removed. Made from plant materials and biodegradable. The carpet is immediately walkable.

- Dry granulate eliminate drying times
- Leaves no residues or watermarks



Container	Item No.	Unit
1 kg Bag	01261	10x1 kg
10 kg Bucket	01262	1x10 kg



### ANIKO 60

#### SPRAY EXTRACTION MACHINE

Spray extraction machine for the professional cleaning of medium-sized carpet surfaces. Suitable for use in trains, cleaning companies, hotels, public facilities, and more.

- Robust construction, tank made of high-density polyethylene
- Brass coupling, suction motor with thermal protection against overload
- High suction power enables good cleaning results and quick drying
- Narrow working width of 30 cm



Size   Weight	Item No.	Unit
38 x 50 x 78 cm   24 kg	ANIKO60	1 Set
<b>Performance</b>	1500 W	
<b>Suction Motor / max. Airflow</b>	two-level / 45 l/sec.	
<b>Fresh/Dirty Water Tank</b>	30 l / 30 l	
<b>Water Column</b>	3000 mmH <sub>2</sub> O	
<b>Pump Performance with Bypass</b>	80 W, 9,0 bar, 4,5 l/min	
<b>Area Performance</b>	80 m <sup>2</sup> /h	
<b>Cable Length</b>	10 m	
<b>Hose Length</b>	5 m	
<b>Noise Level</b>	67 dB	

Product	Item No.	Unit
Plastic Upholstery Adapter	01253	1 pcs.
Aluminum Upholstery Adapter	01252	



### TENAS 4IN1

#### CARPET CLEANER WITH ENCAPSULATION SYSTEM

The system performs the tasks of **five** classic carpet cleaners: Only one product for stain removal, pre-cleaning, extraction cleaning, bonnet cleaning. Dirt is broken down, bound, and encapsulated.

- Polymers prevent re-soiling and graying
- Shortens drying time, protects carpet fibers
- Saves time, money, and space



Container	Item No.	Unit
1 l Bottle	01008	12x1 l
5 l Canister	01028-05	1x5 l





# INNOVATIVE CLEANING







The ULTRA MOBILE SPRAY MOP SYSTEM is suitable for professional use in areas such as hotels, shopping malls, schools, restaurants and other public areas where regular cleaning is required. Ideal for use in areas where effective and targeted cleaning is essential for a clean and hygienic environment.

The light weight of the ULTRA MOBILE SPRAY MOP SYSTEM makes it easy to handle and enables ergonomic, comfortable cleaning.

- No more lifting and carrying heavy buckets required
- No more long preparation necessary
- Ergonomic & easy handling
- High-quality velcro fasteners ensure safe fixation of the mop cover

**Delivery includes:**

- 1 handle
- 1 x VELCRO- mop holder 40 cm
- 1 x ULTRA MICRO BLUE VELCRO MOP COVER 40 cm
- 1 x 500 ml bottle with lid in grey
- 4 x lids to identify different areas of application:

- BLUE ■
- GREEN ■
- YELLOW ■
- RED ■
- GREY ■

Size	Item No.	Unit
40 cm	UMS40SET	1 Set



**ULTRA MOBILE SPRAY MOP SYSTEM**  
Fast, efficient and bucketless cleaning!

Easy removal of 500 ml bottle if needed

A simple press of the trigger to deliver a steady stream of liquid

Ergonomic trigger for easy handling to deliver a steady stream of liquid

Easy refill of liquids without removing the bottle

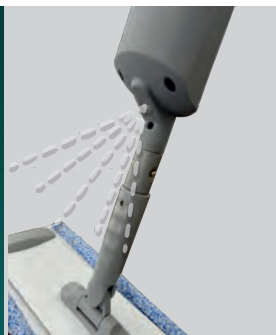

Ideal for use with the  
ARCORA® ULTRA VELCRO  
MOP COVERS 40 cm

**ULTRA MICRO VELCRO MOP COVER**

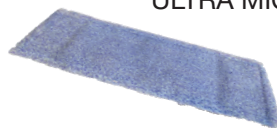

- Article-No.: UKM40MB ■ BLUE  
UKM40MG ■ GREEN  
UKM40MR ■ RED

**ULTRA RUNNER VELCRO MOP COVER**

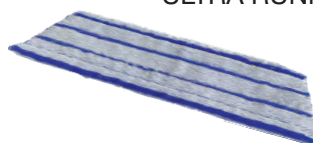

- Article-No.: UKM40RB ■ BLUE  
UKM40RG ■ GREEN  
UKM40RR ■ RED



The 100 % environmentally friendly pad with waterdrop system (water drop perforation) is the ideal pad for maintenance cleaning, **especially with smaller scrubber dryer machines.**

Das PU-PAD LIGHT...

- enables an area performance for maintenance cleaning of up to **80.000 m<sup>2</sup>**.
- is perfect for **smaller scrubber dryer machines.**
- has a special **robustness and durability** due to the composition of polyester, polyether and a fixation of polyurethane.
- is applicable on all types of water resistant elastic and hard floor coverings, even on porcelain stoneware floors and safety floors up to R13.
- has a **higher water absorption** than conventional pads.
- is **100% environmentally friendly** due to the exclusive use of recycled products.

The ideal pad for maintenance cleaning with smaller scrubber dryer machines

### Waterdrop System

#### PLUS-MINUS effect

- Better glide on the floor & better dirt absorption
- Better water distribution & water saving

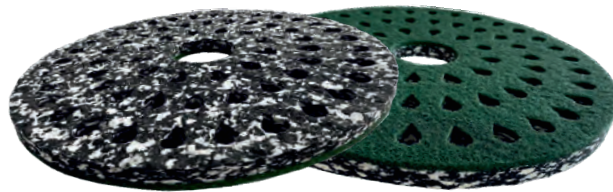
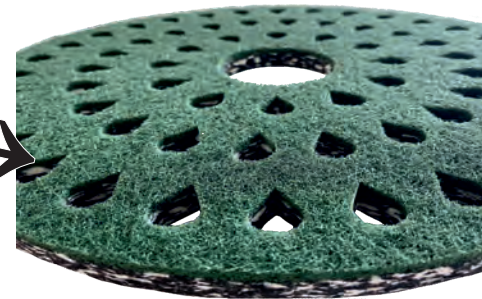
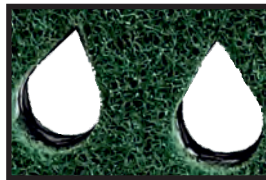

- Due to the applied water drop perforation, the mechanic is additionally supported by the plus/minus effect without damaging the floor → Gentle cleaning
- Gliding the machine over the floor is much easier with the PU PAD Light due to the perforation technology
- To protect the environment, the water drop system enables to reduce the amount of water by the application
- The perforation technology enables better water distribution and dirt absorption

Size	Item No.	Size	Item No.	Unit
8"= 203 mm	PU203LG	15"= 381 mm	PU381LG	5 pcs.
9"= 228 mm	PU228LG	16"= 406 mm	PU406LG	
10"= 254 mm	PU254LG	17"= 432 mm	PU432LG	
11"= 280 mm	PU280LG	18"= 457 mm	PU457LG	
12"= 305 mm	PU305LG	19"= 483 mm	PU483LG	
13"= 330 mm	PU330LG	20"= 508 mm	PU508LG	
14"= 356 mm	PU356LG	21"= 533 mm	PU533LG	



other sizes on request



Available in 5 colours, optimal for waste separation in different areas!

## SPECIFICATIONS

<b>Material:</b>	100% PES										
<b>Colour:</b>	BLUE, GREEN, YELLOW, RED, GREY										
<b>Size:</b>	760 x 1000 mm										
<b>Volume:</b>	120 Liter										
<b>Unit:</b>	25 pcs.										
<b>Item-No.:</b>	<table> <tr> <td>PLS120BL</td> <td>■</td> </tr> <tr> <td>PLS120GR</td> <td>■</td> </tr> <tr> <td>PLS120GE</td> <td>■</td> </tr> <tr> <td>PLS120RO</td> <td>■</td> </tr> <tr> <td>PLS120GU</td> <td>■</td> </tr> </table>	PLS120BL	■	PLS120GR	■	PLS120GE	■	PLS120RO	■	PLS120GU	■
PLS120BL	■										
PLS120GR	■										
PLS120GE	■										
PLS120RO	■										
PLS120GU	■										

**Seamless bottom surface  
to avoid tears & leakage  
of liquids!**

The high-quality disposal bag offers enough space for transporting soiled textiles, mop covers or waste. It is made of **durable polyester**, which is both robust and durable. With the specially designed **seamless construction** of the bottom surface, the disposal bag can be filled without hesitation and without unwanted tears or leakage. Thanks to optimal dimensions and practical construction, the disposal bag can be conveniently attached to cleaning trolleys and used for hygienic disposal during daily cleaning operations.

The bag is washable at 30-60° C, therefore **reusable** and, compared to plastic garbage bags, an **environmentally friendly and economical tool** that ensures order and cleanliness.

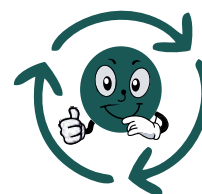

← **Seamless bottom surface**

### PLASTIC GARBAGE BAGS

- Are mostly used as disposable garbage bags
- Cause huge mountains of waste
- It takes between 100 and 500 years for a plastic bag to slowly degrade into harmful small pieces (microplastics)

### PREMIUM-LINE DISPOSAL BAG

- Tear resistant & durable thanks to seamless bottom surface
- Washable, reusable several times
- Environmentally friendly and economical
- Water resistant





**THE SUSTAINABLE INNOVATION!**

# SCRUB & CLEAN *2IN1* MICROFIBER CLOTH

**SCRUB & CLEAN IN ONE!**



- Item No.: ASC4040BL ■  
ASC4040GR ■  
ASC4040GE ■  
ASC4040RO ■  
ASC4040GU ■



**1x SCRUB & CLEAN 2IN1  
MICROFIBER CLOTH**  
replaces approx. 150  
cleaning sponges!



Your partner when it comes to professional cleaning.

## SUSTAINABLE AND INNOVATIVE SOLUTIONS FOR USER-FRIENDLY CLEANING!



### Headquarter

#### ARCORA® INTERNATIONAL GmbH

Marsstrasse 9  
85609 Aschheim/Munich - Germany

Telephone: +49 (0)89/ 14 33 29 3 - 0  
Telefax: +49 (0)89/ 14 33 29 3 - 29

E-Mail: [info@arcora.de](mailto:info@arcora.de)  
Web: [www.arcora-group.com](http://www.arcora-group.com)  
[www.arcorafuture.com](http://www.arcorafuture.com)



Our general terms and conditions apply. Errors and omissions excepted.

Responsible for the content: **ARCORA® INTERNATIONAL GmbH** • Copyright **ARCORA®** © 2023 | 20231001