

**ARCORA<sup>®</sup>**  
PREMIUM CLEANING SYSTEMS

# PREMIUM CLEANING SYSTEMS HEALTHCARE



*CLEANLINESS YOU CAN RELY ON*



# PREFACE

For more than three decades, ARCORA® GROUP has stood for quality, innovation and reliability in the professional cleaning and hygiene industry. With six production sites and a portfolio of more than 1,400 products, we offer our customers a comprehensive range of services – from development and manufacturing to direct delivery from the manufacturer. Through cooperation with an international network of selected specialist wholesalers, we ensure that our products are available worldwide while also providing competent advice and reliable local service.

The healthcare sector places particularly high demands on hygiene, safety and process quality. In hospitals, care facilities, medical practices and healthcare centers, consistent hygiene standards are essential to reliably protect patients, residents, staff and visitors. Thanks to our many years of experience and our focused specialization in this sensitive field, ARCORA® GROUP has extensive expertise that we continuously incorporate into the development of practical, user-oriented solutions.

Our **HealthCare-Line** has been specifically designed to meet the requirements of the healthcare sector. It combines high-performance products with well-designed cleaning systems tailored to efficient workflows, maximum hygiene safety and cost-effective application. Through close cooperation with users and partners from the field, we continuously develop our solutions and actively share our expertise with our customers.

Guided by our principle of “**Hygiene with Responsibility**”, we combine high cleaning performance with efficiency and sustainability. Modern technologies, innovative materials and efficient application concepts enable optimal cleaning results while reducing the use of water, energy and chemicals – creating safe, efficient and hygienic working environments in healthcare facilities.

With this catalog, we present our comprehensive range for professional cleaning and hygiene in healthcare environments – from cleaning textiles, cleaning systems and cleaning trolleys to cleaning and polishing pads, cleaning and maintenance agents, as well as cleaning machines and solutions for surface, sanitary and area hygiene.



*Looking ahead is one of the most crucial tasks of our time.  
This is achieved by combining powerful parameters into a holistic strategy,  
all while recognizing and meeting the complex demands of the market.*

For a clean future,

Sami Memili  
**CEO / PRESIDENT**  
ARCORA® GROUP





Sustainability is increasingly gaining importance and is firmly anchored in ARCORA®'s corporate philosophy. For ARCORA®, a company that looks beyond the horizon, responsibility towards people, the environment, and society is of great significance. Sustainability has been a core value for us from the beginning. In all our products and processes, we consistently ensure that, in addition to economic considerations, we do not neglect social and environmental aspects, always acting with a future-oriented approach.

## THREE-PILLAR MODEL

We are an internationally operating company and bear a special responsibility towards people, our environment, and society. Sustainability is ingrained in our daily practices, guided by the principle: 'Making a difference for generations'. We align ourselves with the Three-Pillar Model to continuously improve. Thinking about tomorrow today and assuming responsibility towards people, the environment, and society is inherent for us as a company.

### **Social Sustainability:**

We advocate for the well-being of individuals within the company and society as a whole.

### **Environmental Sustainability:**

We safeguard the environment and natural ecosystems in the production, distribution, and consumption of our products.

### **Economic Sustainability:**

Quality, service, innovation, and other factors form the basis for our continuous growth.



## FOR A LIVABLE ENVIRONMENT, EVEN IN THE FUTURE!

As a company, we are committed to playing an active role in addressing global climate change. For this reason, we make a dedicated climate contribution: our direct and indirect greenhouse gas emissions are recorded, analyzed, and reduced wherever possible throughout our business operations. We achieve this through a range of measures, including the efficient use of resources, the reduction and responsible disposal of waste, the development of products made from recycled materials, and by raising awareness of climate protection and sustainability among our employees and stakeholders.



## CLIMATE CONTRIBUTION - FOR THE SAKE OF THE ENVIRONMENT

As emissions cannot be completely avoided despite consistent reduction measures, we contribute to climate protection by supporting verified international climate projects. This is based on the recording and accounting of our direct and indirect greenhouse gas emissions in accordance with the Greenhouse Gas Protocol (Scopes 1, 2 and 3). The resulting volume of emissions is offset through certified projects. In this way, we support climate protection initiatives in India, helping to reduce emissions while promoting sustainable development at the local level — with the aim of preserving a livable environment for future generations.

## SOCIAL THINKING - RESPONSIBLE ACTIONS

Our aim is to continuously improve our products and processes in order to establish optimal solutions for greater sustainability. To achieve this, we have set clear objectives that significantly shape our daily actions: in resource-efficient production, in our responsibility towards employees, customers and suppliers, and across our entire value chain. The ARCORA®GROUP is committed to taking social and environmental responsibility beyond its economic activities and to acting with fairness and integrity. Taking responsibility for our employees, business partners, suppliers, as well as for society and the environment is a matter of course for us and an integral part of our corporate philosophy.



## SUSTAINABLE SUPPLY CHAIN

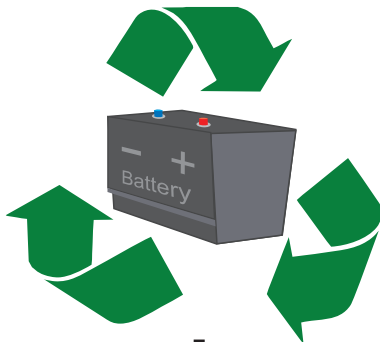

With ECOBLACK® TECHNOLOGY, we've redefined how valuable resources can be recovered and repurposed. At the core of this innovation lies a unique recycling process: empty and discarded battery housings - once considered hazardous waste - are carefully collected, processed, and transformed into a high-quality, robust plastic. This recycled material forms the structural framework of our cleaning trolleys and vacuum cleaners, giving new life to what would otherwise contribute to environmental pollution. By avoiding the use of virgin plastic and instead turning old battery casings into durable components, we not only reduce waste, but also significantly lower CO2 emissions. The ECOBLACK® line stands out with its exceptional durability, user-friendly design, and versatile product range tailored to various cleaning requirements. Every product in this line reflects our belief that sustainability and performance should go hand in hand.

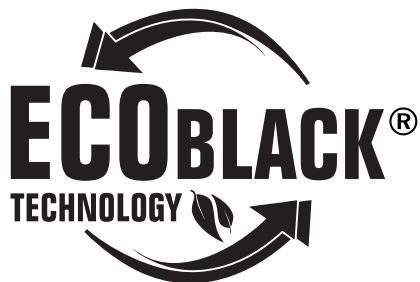

**ECOBLACK® is more than just a material - it's our contribution to a circular economy and a cleaner planet.**



With our commitment to sustainable and responsible production, we set a clear standard for transparent supply chains and the conscious use of resources. Our production facilities meet recognized requirements for the traceability of recycled materials throughout the entire production chain. This ensures that recycled raw materials can be clearly identified and transparently tracked at every stage of the manufacturing process. Our cotton and blended yarn mop covers contain defined proportions of recycled materials and meet high standards in terms of quality, transparency and responsible manufacturing. In this way, we combine the functionality and durability of our cleaning textiles with a sustainable and resource-efficient use of materials.

### **ISO Certifications – Quality, Safety and Responsibility**

Quality, reliability and safety are essential in the healthcare sector. To consistently meet these high standards, our processes and management systems are certified in accordance with internationally recognized ISO standards. These certifications demonstrate our strong commitment to structured processes, continuous improvement and responsible conduct across all areas of our business.



### **ISO 9001:2015 – Quality Management**

Certification according to ISO 9001:2015 confirms our comprehensive quality management system. It ensures that all processes – from development and production through to delivery – are clearly defined, monitored and continuously optimized. The goal is to guarantee consistently high product quality and reliably meet the requirements of our customers.

### **ISO 10002:2018 – Customer-Oriented Complaint Management**

With ISO 10002:2018, we emphasize our strong commitment to customer orientation. The standard establishes transparent and structured procedures for handling feedback and complaints. This ensures that concerns are systematically recorded, evaluated and resolved in a sustainable manner – forming the basis for continuous improvement and long-term partnerships.

### **ISO 14001:2015 – Environmental Management**

Certification according to ISO 14001:2015 demonstrates our responsible environmental management. It confirms that we systematically identify environmental aspects, conserve resources and continuously reduce the environmental impact of our activities. In doing so, we actively contribute to sustainable business practices – also in the interest of our customers in the healthcare sector.

### **ISO 45001:2018 – Occupational Health and Safety**

With ISO 45001:2018, we set clear standards for occupational health and safety. The standard ensures that workplace risks are systematically identified, assessed and minimized. This enables us to create safe working conditions, promote the health of our employees and ensure stable and reliable production processes.

### **Our Commitment**

The combination of these ISO certifications represents a holistic management system that integrates quality, safety, environmental responsibility and customer orientation. For our partners in the healthcare sector, this means verified processes, high transparency and products they can rely on at all times.

# PUBLIC & PATIENT AREAS



# PUBLIC & PATIENT AREAS



## BILANZ® *Fresh*

pH 1-2



### SANITARY MAINTENANCE CLEANER

Fast-acting acid-based sanitary maintenance cleaner with a lasting fresh fragrance that effortlessly removes limescale residues, lime soaps, urine scale, lime-bound grease, rust and grease stains.

- Regular application prevents limescale build-up
- Also suitable for use on intact chrome and other sanitary fittings and for foam triggers

Container	Item-No.	Unit
1 l Bottle	01049	12x1 l
10 l Canister	01039	1x10 l



## SO-KLAR RTU

pH 7



### READY-TO-USE GLASS AND PLASTIC CLEANER

Ready-to-use cleaner with a fresh **summer fragrance** for streak-free cleaning. Effortlessly removes dirt deposits, grease and oil from shiny surfaces.

- **SPRAY - 1x WIPE - DONE!**
- Cleans quickly, residue-free and streak-free
- Gentle on skin and material

Container	Item-No.	Unit
750 ml Bottle	01347	10x750 ml
1 l Bottle	01024	12x1 l
10 l Canister	01023	1x10 l



## CITRUS® *Fresh*

pH 8



### FRAGRANCE-NEUTRAL CLEANER

Highly concentrated, all-purpose maintenance cleaner for streak-free cleaning of hard, water-resistant surfaces such as plastics, glass, ceramics or stainless steel.

- Leaves a radiant shine and pleasant **citrus fragrance**
- Quick-drying and economical to use

Container	Item-No.	Unit
1 l Bottle	01055	12x1 l
10 l Canister	01060	1x10 l



## FLEXAL®

pH 7



### ULTRA POWERFUL MULTIPURPOSE CLEANER

Highly active multi-functional cleaner with excellent properties for streak-free cleaning of PU-coated, coated and uncoated floor coverings. Ideal for cleaning highly water-repellent floor coverings. Low in surfactants and fast drying.

- High dirt-carrying capacity and excellent wetting properties
- Can replace alcohol, all-purpose, automatic and neutral cleaners

Container	Item-No.	Unit
1 l Bottle	01038	12x1 l
10 l Canister	01037	1x10 l



## BIO-LIVE®

pH 8,6-8,9



### ORGANIC CLEANER AND ODOR REMOVER

The odor eliminates even stubborn odours, e.g. in waste bins, dirty laundry depots, toilets, washrooms, etc. The microorganisms break down deep-seated dirt and eliminate unpleasant odors.

- Also suitable for treating stains on carpets, fabrics, table and bed linen
- Leaves a long-lasting pleasant fragrance

Container	Item-No.	Unit
1 l Bottle	01096	12x1 l
5 l Canister	01082-05	1x5 l



## EDOL 2IN1 RTU

pH 5



### STAINLESS STEEL CLEANER AND POLISHING IN ONE

Ready-to-use stainless steel cleaner and care product for all aluminum, anodized, stainless steel and non-ferrous metal surfaces. Leaves a caring film. Prevents rapid resoiling when used regularly

- Removes tarnish on surfaces and appliances as well as fingerprints, water marks and other soiling
- Restores cleaned surfaces to their original shine

Container	Item-No.	Unit
1 l Bottle	01170	12x1 l





**WALES**

pH 4-5



**HAND WASH LOTION AND SHOWER LOTION**

High-quality skin cleansing lotion for gentle cleansing and skin care with a fresh melon fragrance. Leaves a noticeably pleasant and moisturising pleasant feeling on the skin.

- Mild and nourishing, pH value is adapted to the skin
- Can be used as a soap cream and shower gel in all areas

Container	Item-No.	Unit
500 ml Bottle	01188	9x500 ml
5 l Canister	01186	1x5 l
10 l Canister	01187	1x10 l



**DOSING AIDS**



Product	Item-No.	Unit
① Dosing attachment 20 ml for 1 l Bottle	101691	
② Dosing pump 30 ml for 10 l Canister	101529	1 pcs.
③ Filling tap for 10 l Canisters	101429	



**ARSPRAY PROFESSIONAL PREMIUM SPRAY BOTTLE 600**

The robust PROFESSIONAL SPRAY BOTTLES in different colours allow them to be used in different areas. Good resistance to chemicals.



Volume	Item-No.	Unit
600 ml	PSF600BL	1 pcs.
	PSF600GR	
	PSF600GE	
	PSF600RO	
	PSF600WE	



**ARSPRAY FOAM SPRAY CAN 2000**



Product	Volume	Item-No.	Unit
EPDM	2000 ml	7690.R001	8 pcs.
VITON		7688.R001	



**ARSPRAY LIQUID SPRAY CAN 1710**



Product	Volume	Item-No.	Unit
NBR	1710 ml	7405.R011	12 pcs.
VITON		7612.R001	
EPDM		7613.R001	



**MULTI TOOL BELT WORKING BAG**



Versatile hip work bag with comfortable and adjustable strap for ergonomic and flexible working.

- Water-repellent and tear-resistant polyester materials
- 3 storage pockets for spray bottle & cleaning textiles
- 2 flexible snap hooks for tools & accessories

Size   Weight	Item-No.	Unit
52 x 31 cm   ca. 175 g	MTB5231SC	1 pcs.



## SUPER-LINE 300 MICROFIBER CLOTH

**BESTSELLER**

40° - 95°



### BLUE/GREEN/YELLOW/PINK/GREY

The premium microfiber cloth, featuring innovative Superpol fiber, is a small and handy cloth designed for all types of routine cleaning. The innovative microfiber hot-cut technology ensures that the cloths are uniformly prepared. Very high water absorption.

#### Manufactured specifically for the healthcare sector.

- Wave-Cut: Longer service life compared to classic edging tapes thanks to hot-cut technology (Ultra Sonic)
- Lint-free and dimensionally stable

Size   Weight	Item-No.	Unit
32 x 32 cm   ca. 30 g/Cloth	ASPL3232BL	20x10 pcs.
	ASPL3232GR	
	ASPL3232GE	
	ASPL3232RO	
	ASPL3232GU	



## SOFT-LINE 320 MICROFIBER CLOTH

40° - 95°

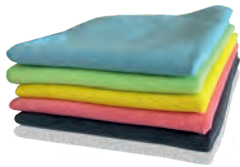

### BLUE/GREEN/YELLOW/PINK/GREY/WHITE

Soft, smooth cloth that absorbs the smallest particles thanks to static charge and capillary action. Ideal for maintenance cleaning and polishing work. For optimum and lint-free cleaning results.

- Above-average service life
- Can be used on all surfaces
- Double-stitched edge protection with high-quality binding tape
- Maximum absorption of dirt and water

Size   Weight	Item-No.	Unit
40 x 40 cm   ca. 50 g/Cloth	ASL4040BL	20x10 pcs.
	ASL4040GR	
	ASL4040GE	
	ASL4040RO	
	ASL4040GU	
	ASL4040WE	



## BASIC-LINE 210 MICROFIBER CLOTH

40° - 95°



### BLUE/GREEN/YELLOW/PINK/GREY

The optimal and favourable cloth for maintenance and basic cleaning. Can be used on all surfaces. Also ideal for final building cleaning.

- Double-stitched edge protection with high-quality binding tape
- Very good cleaning results
- Dimensionally stable and universally applicable

Size   Weight	Item-No.	Unit
38 x 38 cm   ca. 32 g/Cloth	ABL3838BL	20x10 pcs.
	ABL3838GR	
	ABL3838GE	
	ABL3838RO	
	ABL3838GU	



## FINE-LINE MICROFIBER GLASS CLOTH

40° - 95°



### BLUE/GREEN/YELLOW/PINK

"A must for glass cleaning". This cloth enables streak-free and lint-free cleaning of glass, mirrors and chrome.

- Double-stitched edge protection with high-quality binding tape
- Above-average service life
- Maximum absorption of dirt and water
- Super absorbent: absorbs 8 times its own weight in liquid

Size   Weight	Item-No.	Unit
40 x 40 cm   ca. 52 g/Cloth	AFL4040BL	20x10 pcs.
	AFL4040GR	
	AFL4040GE	
	AFL4040RO	



## SCRUB & CLEAN 2IN1 MICROFIBER CLOTH

Alternative to the cleaning sponge!

40° - 95°

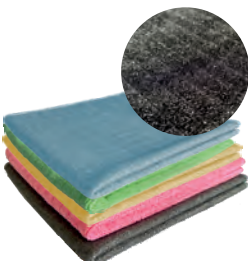

### BLUE/GREEN/YELLOW/PINK/GREY

The cloth is ideal for stubborn dirt and encrustations, especially in kitchens and sanitary areas.

- With active dirt-removing side and finely microfiber side
- Excellent dirt-removing power thanks to the bristles
- High dirt and water absorption thanks to microfiber side
- For thorough and SCRATCH-FREE cleaning of surfaces

Size   Weight	Item-No.	Unit
40 x 40 cm   ca. 45 g/Cloth	ASC4040BL	30x5 pcs.
	ASC4040GR	
	ASC4040GE	
	ASC4040RO	
	ASC4040GU	

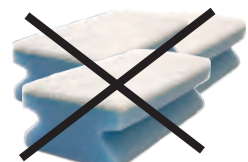

**NON-WOVEN GENERAL PURPOSE CLOTH**

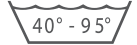

**BLUE/GREEN/YELLOW/PINK/WHITE**

Universally applicable, lint-free cleaning cloths that impress with their high quality, durability and versatility. The cloths reliably absorb dirt, dust and liquids and are characterised by their high absorbency and excellent dirt pick-up.

- For universal use: For almost all surfaces
- Suitable for dry, damp and wet applications as well as for **disinfection**
- Highly absorbent: Excellent dirt pick-up with no linting
- Washable and reusable
- OEKO-TEX® Standard 100 certified

Size   Weight	Item-No.	Unit
36 x 40 cm   ca. 110 g/m <sup>2</sup>	VA3640BL110	20x10 pcs.
	VA3640GR110	
	VA3640GE110	
	VA3640RO110	
	VA3640WE110	

Available in additional sizes and weights upon request.

**UNIVERSAL CLOTH 2.0**



**BLUE/GREEN/YELLOW/RED**

Is ideal for cleaning all smooth surfaces. The particularly high absorption rate ensures quick and efficient dirt and water removal. It's very dependable - removing dirt, dust and moisture without leaving scratches or streaks.

- Versatile and durable
- Coated fleece: Highly absorbent & robust
- Lint-free & streak-free cleaning

Size   Weight	Item-No.	Unit
35 x 40 cm   ca. 140 g/m <sup>2</sup>	AUT3540BL	20x10 pcs.
	AUT3540GR	
	AUT3540GE	
	AUT3540RO	

**INDIVIDUAL COLOUR SELECTION**

The seams and binding tapes on the back of our mop covers can be color-coded according to their intended use – for example to differentiate between various facilities or specific areas such as operating rooms. Special colors are available upon request. In addition, each mop cover can be equipped with an individual color-coding system.

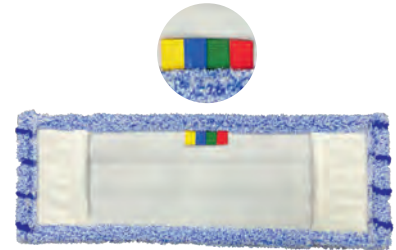

**LABELS / EMBROIDERY**

A label with your own company logo increases the recognition value of your company. At the same time, it also serves as an advertising medium, for self-identification, and to enhance your professional image. The label can be attached to all models as a high-quality embroidered or satin label.

We are also happy to produce private label labels for our microfiber cloths on request.



We produce with your company logo



**Purchase quantity Own Label:**

**Mop covers:**  
40 cm from 525 pieces  
50 cm from 500 pieces  
Price on request

**Microfibre cloths:**  
Purchase quantity &  
Price on request

**TRANSPONDER / TAGS / RFID-TAGS**

We are also happy to sew in transponders or tags into mop covers. Laundries and other businesses find the stored data extremely useful. Price on request.





## HOSPITAL HYGIENE MOP

**BESTSELLER**

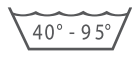

### BLUE, GREEN, YELLOW, RED

Ideal for maintenance cleaning of resilient and hard floor coverings, smooth, coated and uncoated floor coverings. Particularly suitable for use in the healthcare sector thanks to 4 high-quality yarn fibres. Ideal for preparation.

- Ideal dirt and water absorption
- Very high area performance thanks to optimum distribution of the yarns
- The outer fringes fibres ensure optimum gliding properties

Size   Weight	Item-No.	Unit
40 cm   ca. 160 g	EHHM40BL	75 pcs.
	EHHM40GR	
	EHHM40GE	
	EHHM40RO	



## HOSPITAL HYGIENE PLUS MOP BLUE/GREEN



### MICROFIBER EDGE

Ideal for maintenance cleaning of resilient floor coverings, hard floor coverings, as well as coated and uncoated floor coverings. Particularly suitable for use in the healthcare sector thanks to 4 high-quality yarn fibres. Features a microfiber edge for improved performance and effective edge cleaning. Ideal for preparation.

- Very high dirt and water absorption
- Universally applicable
- Optimum gliding properties for fatigue-free working

Size   Weight	Item-No.	Unit
40 cm   ca. 125 g	EHHPM40BL	75 pcs.
	EHHPM40GR	

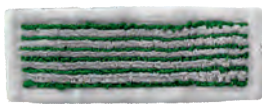

## MICRO BLUE/GREEN/RED 2.0 DB-FC

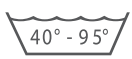

### WITH COVER SHEET "THE MIRACLE CLEANER"

High-performance mop cover for maintenance, wet, and dry cleaning. Suitable for resilient and hard flooring, laminate, as well as smooth and porous surfaces. Ideal for use in healthcare facilities and industrial laundries. Also suitable for preparation.

- Improved mechanics and optimum cross-linking of the cleaning solution on the floor thanks to the tightly woven microfibre yarn
- Excellent dirt and water absorption and higher surface performance

Size   Weight	Item-No.	Unit
40 cm   ca. 101 g	EMB40DBFC	75 pcs.
	EMG40DB	
	EMR40DB	

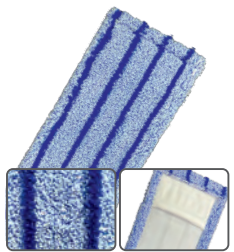

## RUNNER BLUE/GREEN 2.0 DB-FC

**BESTSELLER**

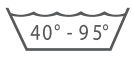

### WITH COVER SHEET "THE SMOOTH-RUNNING-SENSATION"

Mop pad with excellent gliding properties thanks to **smooth-gliding bristles**. Suitable for routine cleaning of resilient and hard floor coverings, laminate, as well as smooth and porous surfaces. Ideal for use in healthcare facilities and industrial laundries. Also suitable for preparation.

- Excellent dirt and water absorption and higher surface performance
- Improved mechanics and optimum cross-linking of the cleaning solution on the floor thanks to the tightly woven microfibre yarn
- Outstanding gliding properties thanks to smooth-gliding bristles on almost all surfaces for fatigue-free work

Size   Weight	Item-No.	Unit
40 cm   ca. 104 g	ERB40DBFC	75 pcs.
	ERG40DBFC	





### DOUBLE MOP 2.0 MICRO PLUS BLUE/GREEN/RED

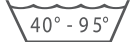

#### MICROFIBER EDGE

Ideal for maintenance cleaning of resilient floor coverings, hard floor coverings, smooth, coated and uncoated floor coverings. Thanks to the 4 high-quality yarn fibers, ideal for use in the healthcare sector.

- Optimum dirt-removing power and dirt absorption thanks to special yarn technology and high microfiber content
- Very high water absorption and absorbency thanks to a high-quality fiber structure
- Good gliding properties for fatigue-free working

Size   Weight	Item-No.	Unit
40 cm   ca. 225 g	DMP-BL-2.0	50 pcs.
	DMP-GR-2.0	
	DMP-RO-2.0	

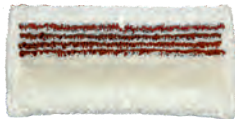
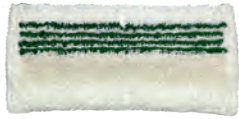

### FLAT PRESS MOP HOSPITAL HYGIENE PLUS BLUE/GREEN/RED

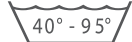

#### WITH COVER SHEET & SPECIAL FPM POLYESTER POCKETS

Ideal for maintenance cleaning of resilient floor coverings, hard floor coverings, as well as coated and uncoated floor coverings. Particularly suitable for use in the healthcare sector thanks to 4 high-quality yarn fibres. Features a microfiber edge for improved performance and effective edge cleaning. Ideal for preparation.

- Very high area performance, water and dirt absorption
- Suitable for all commercially available flat press systems

Size   Weight	Item-No.	Unit
40 cm   ca. 115 g	HPFPM40BL	75 pcs.
	HPFPM40GR	
	HPFPM40RO	

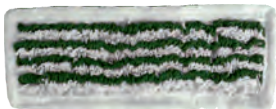

### FLAT PRESS MOP MICRO BLUE 2.0 DB-FC

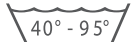

#### WITH COVER SHEET & SPECIAL FPM POLYESTER POCKETS

High-performance mop cover for maintenance, wet, and dry cleaning. Suitable for resilient and hard flooring, laminate, as well as smooth and porous surfaces. Ideal for use in healthcare facilities and industrial laundries. Also suitable for preparation.

- Improved mechanics and optimum cross-linking of the cleaning solution on the floor thanks to the tightly woven microfiber yarn
- Excellent dirt and water absorption and higher surface performance
- Suitable for all commercially available flat press systems

Size   Weight	Item-No.	Unit
40 cm   ca. 80 g	EMBD40FPM	75 pcs.

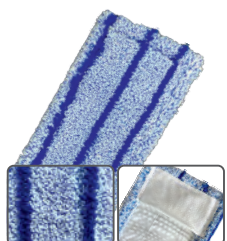

### FLAT PRESS MOP RUNNER BLUE 2.0 DB-FC

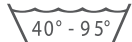

#### WITH COVER SHEET & SPECIAL FPM POLYESTER POCKETS

Mop pad with excellent gliding properties thanks to smooth-gliding bristles. Suitable for routine cleaning of resilient and hard floor coverings, laminate, as well as smooth and porous surfaces. Ideal for use in healthcare facilities and industrial laundries. Also suitable for preparation.

- Excellent dirt and water absorption and higher surface performance
- Improved mechanics and optimum cross-linking of the cleaning solution on the floor thanks to the tightly woven microfiber yarn
- Outstanding gliding properties thanks to smooth-gliding bristles on almost all surfaces for fatigue-free work
- Suitable for all commercially available flat press systems

Size   Weight	Item-No.	Unit
40 cm   ca. 85 g	ERBD40FPM	75 pcs.





## PREMIUM RED MICRO BRUSH MOP

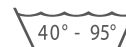

### WITH FlowPocket TECHNOLOGY

Mop covers with water- and air-permeable pocket technology.

- Polyamide bristle stripes for optimal dirt removal
- High scrubbing effect against dirt and stains
- Effective on stubborn soiling
- Ideal for wet cleaning of rough and heavily textured floors
- Smooth gliding for fatigue-free working

Size   Weight	Item-No.	Unit
40 cm   ca. 115 g	PRWD40	75 pcs.



## MOP COVERS FEATURING WATER AND AIR PERMEABLE POCKET TECHNOLOGY

## ACRYLIC DRY MOP BLUE



60 cm WITH POCKETS  
80 cm + 100 cm + 130 cm WITH POCKETS & CORD

Ideal for dry cleaning of elastic and hard floor coverings.

- Very high area performance
- Ideal for large areas such as gyms and reception halls
- Good gliding properties for fatigue-free work
- Dry application only

Size   Weight	Item-No.	Unit
60 cm   ca. 190 g	OR60	50 pcs.
80 cm   ca. 230 g	OR80	40 pcs.
100 cm   ca. 280 g	OR100	30 pcs.
130 cm   ca. 380 g	OR130	25 pcs.



## PROFI MOP HOLDER STANDARD

GREY OR BLUE

Suitable for all commercially available mop covers. Thanks to its light-weight and robust design, this mop holder ensures ergonomically efficient use. Available in two different colors GREY or BLUE.

Size	Item-No.	Unit
40 cm	PMH40GU	10 pcs.
	PMH40BL	
50 cm	PMH50GU	10 pcs.
	PMH50BL	

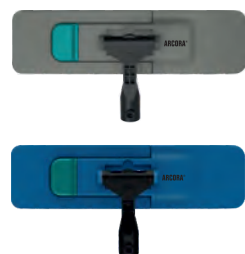

## PROFI MOP HOLDER MAGNET

GREY OR BLUE

The mop holder has an ideal fit for all commercially available covers. Thanks to its light-weight, this mop holder ensures ergonomically efficient use. Available in two different colors GREY or BLUE.

Size	Item-No.	Unit
40 cm	PMN40GU	10 pcs.
	PMN40BL	
50 cm	PMN50GU	10 pcs.
	PMN50BL	

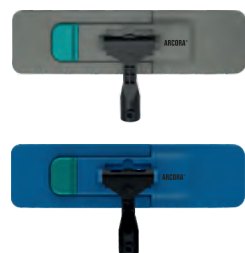

## DAMP AND ACRYLIC MOP HOLDER

GREY-BLUE

Mop holder for damp mops and acrylic mops.

- 60-100 cm: Plastic base plate
- 130 cm: Metal construction

Size	Item-No.	Unit
60 cm	FWMH60	24 pcs.
80 cm	FWMH80	
100 cm	FWMH100	
130 cm	FWMH130	1 pcs.



60 cm - 80 cm - 100 cm



130 cm



### ALUMINIUM HANDLE 140 cm

#### BLUE/GREEN/RED/YELLOW/GREY

Robust aluminium handle with ergonomic grip in various colours.

- More stable than conventional aluminium handles
- Stainless material
- Retains its shape even under heavy pressure
- With integrated eyelet for hanging

Size	Item-No.	Unit
140 cm	AS140BL	50 pcs.
	AS140GRN	
	AS140RO	
	AS140GE	
	AS140GR	



### PROFI TELESCOPIC HANDLE 2-PART

#### GREY-BLACK

Robust and ergonomic handle made of high-quality aluminum with a reach of up to 180 cm. Suitable for hanging. With rubberized handle.

- Length: 100-180 cm
- With integrated eyelet for hanging
- Practical, firmly clamping quick-release fastener in black-turquoise

Size	Item-No.	Unit
100-180 cm	TST180GU	20 pcs.



### SWEEPING SET DELUXE

#### TURQUOISE-DARK GREY

Robust sweeping set with broom and folding dustpan incl. clip. For cleaning floors without having to bend down. Dustpan opens on contact with the floor and closes when lifted.

- Bristles pick up the finest dust and dirt
- Practical holder on the handle ensures space-saving and easy storage of the sweeping set
- With integrated eyelet for hanging

Size	Item-No.	Unit
245 x 280 x 1000 mm	KS8DLX	8 pcs.



### LAMBSWOOL DUSTER WITH TELESCOPIC HANDLE 270 cm

#### FOR REMOVING DUST

Ideal for removing dust from shelves and surfaces thanks to its antistatic effect. Soft and gentle on furniture. Telescopic handle extends up to 270 cm for hard-to-reach areas.

Size	Item-No.	Unit
70-270 cm	SWLW270	1 pcs.



### ULTRA INTERIOR COVER WITH FLEXIBLE HOLDER 60 cm

#### FOR REMOVING DUST AND LIGHT DIRT

Ideal for thorough dust removal on shelves, tables, cupboards, picture frames and ceiling pipes. The flexible holder with high-quality microfibre cover allows effortless cleaning even in hard-to-reach places.

For higher areas, the holder can be combined with a telescopic handle and matching safety cone.

Size	Item-No.	Unit
① L: 60 cm	UIBH60BL	1 pcs.
② 90-150 cm	UTST150	



①

②

Length: 60 cm

ULTRA Aluminium Telescopic handle 90-150 cm



①

### WARNING SIGN STANDARD AND PENGUIN

#### YELLOW/CAUTION WET FLOOR

- Robust plastic design in signal yellow
- Set up without having to bend down
- Tilt and break-proof
- Different languages on request



②

Product	Size	Item-No.	Unit
① Standard	320 x 620 mm	01193DE	20 pcs.
② Penguin	320 x 680 mm	WSPNG-EN	11 pcs.





## COPPER PRODUCTS

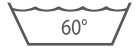

### COPPER SPONGE AND COPPER CLOTH

Cement residue, graffiti, limescale, adhesive residue, hairspray and silicones? No problem for the copper products. They ensure gentle cleaning of pots and pans, sinks, taps, enamel, glass, mirrors, ceramic hobs, stainless steel and non-lacquered metal parts. Rust deposits on cutlery can also be removed.

- Only water is required for cleaning
- Scratch-free application
- Can be reused several times, washable at 60 °C

Product	Size   Weight	Item-No.	Unit
Copper sponge	16 x 10 x 2,8 cm   ca. 22 g	01240	
Large copper cloth	16 x 19 cm   ca. 25 g	01238	
Small copper cloth	10 x 14 cm   ca. 9 g	01239	
Loose copper cloth	25 x 25 cm   ca. 34 g	01241	
Copper pot scrubber	ca. 40 g	01335	



## PROFESSIONAL GRIP FLEECE SPONGE

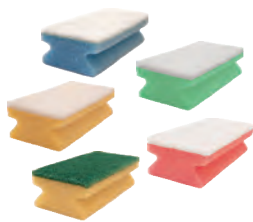

### BLUE-WHITE/GREEN-WHITE/YELLOW-GREEN/YELLOW-WHITE/PINK-WHITE

The durable non-woven grip sponges are ideal for sensitive surfaces. For thorough and scratch-free cleaning.

- High water absorption
- With grip to protect hands and fingernails

Size   Weight	Item-No.	Unit
150 x 70 x 45 mm   ca. 13 g/Sponge	01141BLW	10x10 pcs.
	01144GRW	
	01145GEG	
	01143GEW	
	01142ROW	



## LONGLIFE SPONGE

**BESTSELLER**

The sponge of the new generation

### BLUE/GREEN/YELLOW/PINK

Durable cleaning sponge of the new generation. The robust LONGLIFE side thoroughly removes stubborn dirt without scratching surfaces.

- Replaces the conventional yellow-green sponge
- High water absorption with ideal scrubbing effect
- For thorough and SCRATCH-FREE cleaning

Size   Weight	Item-No.	Unit
150 x 70 x 45 mm   ca. 12 g/Sponge	LLS15070BLO	10x10 pcs.
	LLS15070GRO	
	LLS15070GEO	
	LLS15070ROO	



## PU-PAD SPONGE

### BLUE/GREEN/YELLOW/RED

Durable sponge with PU back for damp and wet cleaning of insensitive surfaces. The sponge is ideal for use in the kitchen and removing stubborn dirt.

- Particularly robust and high water absorption

Size   Weight	Item-No.	Unit
150 x 70 x 45 mm   ca. 17 g/Sponge	PU15070BL	10x10 pcs.
	PU15070GR	
	PU15070GE	
	PU15070RO	

## PROFI MELAMINE POWER-CLEAN

### STAIN ERASER

Effortlessly removes dirt from smooth surfaces using water and without the addition of chemical cleaning agents.

- Flexible application options
- Erases stubborn stains, residues, edges and streaks

Size	Item-No.	Unit
120 x 65 x 30 mm	12653	10 pcs.



## FRAGRANCE URINAL SCREEN

### MAXI

The **MAXI** FRAGRANCE URINAL SCREEN ensures a fresh and clean odor, especially in sanitary areas. For all standard urinals.

- Effective fragrance for at least 30 days
- Prevents blockages caused by cigarettes or chewing gum
- Special nubs prevent urine splashes



Size	Item-No.	Unit
Ø 17 cm	1717US-TF 1	1 pcs.
	1717US-TP 2	
	1717US-LE 3	
	1717US-MN 4	
	1717US-CH 5	
	1717US-SP 6	



## FRAGRANCE URINAL SCREEN

### MINI

The economical **MINI** FRAGRANCE URINAL SCREEN ensures a fresh and clean odor, especially in sanitary areas. For all standard urinals.

- Effective fragrance for at least 30 days
- Prevents blockages caused by cigarettes or chewing gum
- Special nubs prevent urine splashes

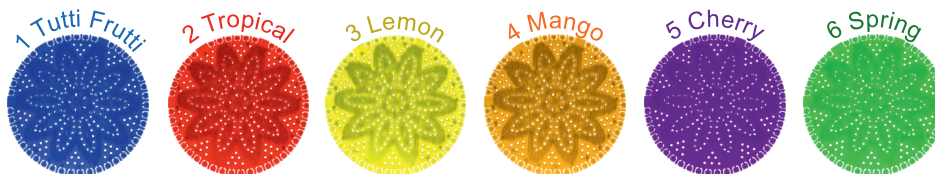

Size	Item-No.	Unit
Ø 14 cm	1414US-TF 1	1 pcs.
	1414US-TP 2	
	1414US-LE 3	
	1414US-MN 4	
	1414US-CH 5	
	1414US-SP 6	

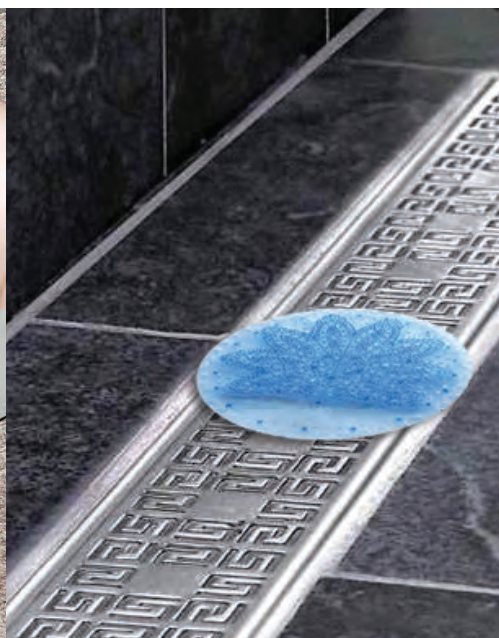



# KITCHEN HYGIENE



# KITCHEN HYGIENE



## INPUR®

pH 13,5

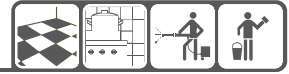

### FAT REMOVER ALKALINE / POWERFUL KITCHEN CLEANER

Powerfully cleans protein and oil-soiled alkali-resistant surfaces of all kinds. Ideal for cleaning in food processing companies.

- Low-foaming, suitable for machine use, suitable for high-pressure devices
- Particularly suitable for cleaning heavily grease-soiled floors, work surfaces and extractor hoods

Container	Item-No.	Unit
1 l Bottle	01021	12x1 l
10 l Canister	01018	1x10 l



## CHLORADO®

pH 12-13



### KITCHEN CLEANER WITH ACTIVE CHLORINE

Highly concentrated basic kitchen cleaner with active chlorine for the removal of vegetable and animal fats, oils, blood, protein and mold. Kills all bacteria, fungi and viruses. Suitable for the food industry according to HACCP.

- Strong bleaching effect on tea, coffee, fruit and mildew stains
- Cleans quickly and ensures hygienic cleanliness in the food industry

Container	Item-No.	Unit
10 l Canister	01138	1x10 l



## POWER-CLEAN

pH 13,5



### GRILL CLEANER AND SMOKE RESIN REMOVER

Highly concentrated, alkaline intensive cleaner and smoke resin remover that works quickly and independently.

- Can be used on hot and cold surfaces
- Dissolves burnt-on, charred and encrusted residues
- Can also be used in high dilution as an intensive grease remover

Container	Item-No.	Unit
1 l Bottle	01006	12x1 l
10 l Canister	01015	1x10 l



## ORKAN

pH 9,7

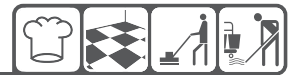

### COLD STORE CLEANER UP TO -30°C

Special cleaner for cleaning surfaces down to -30°C. Removes oily and greasy soiling and cleans even heavily soiled floors.

- Hygienically clean effect
- No defrosting of the cold store necessary

Container	Item-No.	Unit
10 l Canister	01089	1x10 l



## EDOL 2IN1 RTU

pH 5



### STAINLESS STEEL CLEANER AND POLISHING IN ONE

Ready-to-use stainless steel cleaner and care product for all aluminum, anodized, stainless steel and non-ferrous metal surfaces. Leaves a caring film. Prevents rapid resoiling when used regularly

- Removes tarnish on surfaces and appliances as well as fingerprints, water marks and other soiling
- Restores cleaned surfaces to their original shine

Container	Item-No.	Unit
1 l Bottle	01170	12x1 l



## BIO-LIVE®

pH 8,6-8,9



### ORGANIC CLEANER AND ODOR REMOVER

The odor eliminates even stubborn odours, e.g. in waste bins, dirty laundry depots, toilets, washrooms, etc. The microorganisms break down deep-seated dirt and eliminate unpleasant odors.

- Also suitable for treating stains on carpets, fabrics, table and bed linen
- Leaves a long-lasting pleasant fragrance

Container	Item-No.	Unit
1 l Bottle	01096	12x1 l
5 l Canister	01082-05	1x5 l



### BAD SMELL...

...from your drain? From the trash cans?  
Or have your hotel room guests smoked?



**Not anymore with BIO-LIVE! With BIO-LIVE, odors are completely eliminated and not just masked with scented oil!**



## CLEATOR

### DESCALER FOR COMMERCIAL MACHINES

Acidic, liquid limescale remover that removes limescale deposits, water stains and other deposits on internal machine surfaces.

- For hot water appliances, dishwashers, coffee machines, washing machines and similar appliances

pH 1,7



Container	Item-No.	Unit
1 l Bottle	01165	12x1 l
10 l Canister	01185	1x10 l



## CITRUS POWER

### PREMIUM HAND DISHWASHING LIQUID WITH CITRUS POWER

Skin-friendly, neutral, surfactant-containing dishwashing liquid with a pleasant **citrus fragrance**. Suitable for the gentle cleaning of all water-resistant surfaces. Optimum grease and dirt dissolving power.

- For sparkling clean, shiny crockery
- Good rinsing properties for a brilliant shine without drying off

pH 7



Container	Item-No.	Unit
1 l Bottle	01183	12x1 l
10 l Canister	01178	1x10 l



## PROTAP 2IN1

### DISHWASHING CLEANING TABS

Highly concentrated dishwasher tabs with integrated rinse component for commercial and domestic dishwashers.

- Cleaning and rinsing in one with 2-phase tabs
- Removes stubborn and dried-on soiling, Gentle on glass and decor
- Rinse aid prevents water stains and ensures a brilliant shine

pH 10



Container	Item-No.	Unit
60 Tabs in Box	01163	5x60 Tabs
180 Tabs Bucket	01161	180 Tabs



## ECO PLUS

### DISHWASHING DETERGENT

Powerful and reliable dishwashing and soil removal agent for the automated cleaning of crockery and kitchen utensils in the food industry.

- Alkaline detergent with good starch-dissolving effect and chlorine content

pH 13



Container	Item-No.	Unit
12 kg Canister	01179	1x12 kg



## ECO PLUS-CF

### CHLORINE-FREE DISHWASHING DETERGENT

Powerful, environmentally friendly crockery cleaner without chlorine for the automated cleaning of crockery and kitchen utensils in the food industry and in kitchens.

- Alkaline cleaner with good, starch-dissolving effect, chlorine-free
- Gently cleans crockery, glasses, cutlery etc.

pH 11,8



Container	Item-No.	Unit
12 kg Canister	01306	1x12 kg



## ECO-GLS

### GLASS CLEANER FOR DISHWASHERS

Concentrated and chlorine-free glasswasher detergent with increased cleaning performance.

- Also removes incrustations and very greasy soiling, chlorine-free

pH 11,9



Container	Item-No.	Unit
12 kg Canister	01181	1x12 kg



## ECO SAUER

### DISHWASHING DETERGENT "ACID"

Acidic dishwashing detergent that ensures a brilliant shine on glass and crockery. Allows water to run off without beads or streaks

- No formation of residues or deposits on the crockery

pH 2,5



Container	Item-No.	Unit
10 l Canister	01182	1x10 l



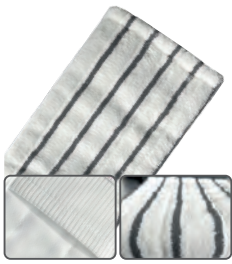

## PREMIUM GREY MICRO BRUSH MOP

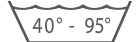

### WITH FlowPocket TECHNOLOGY

Mop covers with water- and air-permeable pocket technology.

- Polyamide bristle stripes for optimal dirt removal
- High scrubbing effect against dirt and stains
- Effective on stubborn soiling
- Ideal for wet cleaning of rough and heavily textured floors
- Smooth gliding for fatigue-free working

Size   Weight	Item-No.	Unit
40 cm   ca. 115 g	PGWD40	75 pcs.
50 cm   ca. 140 g	PGWD50	50 pcs.



## EXCELLENT SCRUB-IGEL 2.0 FC-MOP GREY

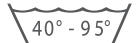

### WITHOUT COVER SHEET WITH HEDGEHOG BRISTLE

Suitable for removing medium to heavy soiling on hard floor coverings and porous stone floors. Hedgehog bristles effortlessly loosen dirt and enable excellent gliding properties on difficult, uneven or rough floors. Not suitable for coated floors.

- Particularly suitable for non-slip floors and safety floors
- Strong scrubbing effect for dirt and stain removal
- Extreme scrubbing properties

Size   Weight	Item-No.	Unit
40 cm   ca. 80 g	ESM40FC	75 pcs.
50 cm   ca. 110 g	ESM50FC	50 pcs.

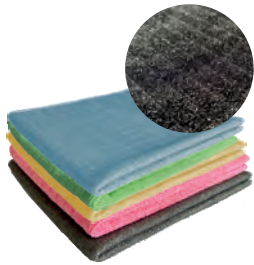

## SCRUB & CLEAN 2IN1 MICROFIBER CLOTH

Alternative to the cleaning sponge!



### BLUE/GREEN/YELLOW/PINK/GREY

The cloth is ideal for stubborn dirt and encrustations, especially in kitchens and sanitary areas.

- With active dirt-removing side and finely microfiber side
- Excellent dirt-removing power thanks to the bristles
- High dirt and water absorption thanks to microfiber side
- For thorough and SCRATCH-FREE cleaning of surfaces

Size   Weight	Item-No.	Unit
40 x 40 cm   ca. 45 g/Cloth	ASC4040BL	30x5 pcs.
	ASC4040GR	
	ASC4040GE	
	ASC4040RO	
	ASC4040GU	



## GLASS-SHINE MICROFIBER GLASS POLISHING CLOTH

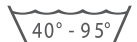

### WHITE WITH TURQUOISE OVERLOCK EDGE

This microfiber cloth is ideal for polishing and cleaning glasses. Ideal for use in hotels, restaurants and bars (HoReCa).

- Cleans lint and streak-free and leaves surfaces shiny
- Maximum absorption of dirt and water
- Also ideal for crockery and cutlery

Size   Weight	Item-No.	Unit
50 x 80 cm   ca. 64 g/Cloth	AGP5080TU	1 pcs.



## MULTI-SHINE MICROFIBER DISH CLOTH

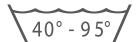

### BLUE

For ideal, lint-free and grease-absorbing cleaning on all smooth surfaces. Consists of a very fine and easy-care fabric.

- Double-stitched edge protection with high-quality binding tape
- Maximum absorption of dirt and water
- Universally applicable

Size   Weight	Item-No.	Unit
50 x 60 cm   ca. 52 g/Cloth	AGS5060BL	15x10 pcs.





## COPPER PRODUCTS



### COPPER SPONGE AND COPPER CLOTH

Cement residue, graffiti, limescale, adhesive residue, hairspray and silicones? No problem for the copper products. They ensure gentle cleaning of pots and pans, sinks, taps, enamel, glass, mirrors, ceramic hobs, stainless steel and non-lacquered metal parts. Rust deposits on cutlery can also be removed.

- Only water is required for cleaning
- Scratch-free application
- Can be reused several times, washable at 60 °C

Product	Size   Weight	Item-No.	Unit
Copper sponge	16 x 10 x 2,8 cm   ca. 22 g	01240	
Large copper cloth	16 x 19 cm   ca. 25 g	01238	
Small copper cloth	10 x 14 cm   ca. 9 g	01239	100 pcs.
Loose copper cloth	25 x 25 cm   ca. 34 g	01241	
Copper pot scrubber	ca. 40 g	01335	40x10 pcs.

## PROFESSIONAL GRIP FLEECE SPONGE



### BLUE-WHITE/GREEN-WHITE/YELLOW-GREEN/YELLOW-WHITE/PINK-WHITE

The durable non-woven grip sponges are ideal for sensitive surfaces. For thorough and scratch-free cleaning.

- High water absorption
- With grip to protect hands and fingernails

Size   Weight	Item-No.	Unit
150 x 70 x 45 mm   ca. 13 g/Sponge 	01141BLW	10x10 pcs.
	01144GRW	
	01145GEG	
	01143GEW	
	01142ROW	

## LONGLIFE SPONGE

### The sponge of the new generation



### BLUE/GREEN/YELLOW/PINK

Durable cleaning sponge of the new generation. The robust LONGLIFE side thoroughly removes stubborn dirt without scratching surfaces.

- Replaces the conventional yellow-green sponge
- High water absorption with ideal scrubbing effect
- For thorough and SCRATCH-FREE cleaning

Size   Weight	Item-No.	Unit
150 x 70 x 45 mm   ca. 12 g/Sponge 	LLS15070BLO	10x10 pcs.
	LLS15070GRO	
	LLS15070GEO	
	LLS15070ROO	

## PU-PAD SPONGE

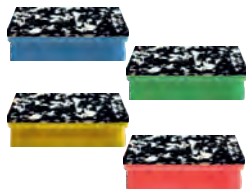

### BLUE/GREEN/YELLOW/RED

Durable sponge with PU back for damp and wet cleaning of insensitive surfaces. The sponge is ideal for use in the kitchen and removing stubborn dirt.

- Particularly robust and high water absorption

Size   Weight	Item-No.	Unit
150 x 70 x 45 mm   ca. 17 g/Sponge 	PU15070BL	10x10 pcs.
	PU15070GR	
	PU15070GE	
	PU15070RO	

## METAL POT CLEANER



### 40 & 60 g

This pot cleaner is ideal for removing stubborn stains. Cleans gently, effectively and without scratching.

- Cleans powerfully and hygienically
- Stainless and very durable

Weight	Item-No.	Unit
ca. 40 g	01194	30x10 pcs.
ca. 60 g	01194-60	20x10 pcs.



## STAINLESS STEEL SPIRAL POT CLEANER



### 40 & 60 g

For removing limescale and dirt deposits in the kitchen area. Cleans gently, effectively and without scratching.

- Cleans powerfully and hygienically
- Stainless and durable

Weight	Item-No.	Unit
ca. 40 g	01195	10x10 pcs.
ca. 60 g	01195-60	5x10 pcs.



## IN-BOX MICROFIBER CLOTH

40° - 95°

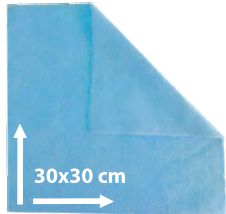

ALWAYS AT HAND!

### BLUE/GREEN/YELLOW/PINK/GREY

This practical box ensures maximum flexibility. Ideal for taking with you in mobile devices and space-saving for storage even in the smallest of spaces.

- Perfect for daily cleaning of all surfaces
- Alternative to paper towels
- Washable up to 300 times
- Always accessible - in a practical box
- Edge: ultrasonic cut → strong, stable and durable
- Content: 50 space-saving towels, each 30 × 30 cm



Size   Weight	Item-No.	Unit
30 x 30 cm   ca. 200 g/m <sup>2</sup>	BMF50BL	8 Boxes
	BMF50GR	
	BMF50GE	
	BMF50RO	
	BMF50GU	



## UNIVERSAL CLOTH 2.0

40° - 95°

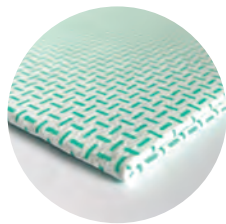
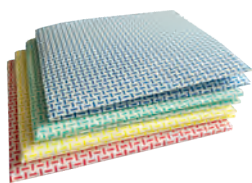

### BLUE/GREEN/YELLOW/RED

Is ideal for cleaning all smooth surfaces. The particularly high absorption rate ensures quick and efficient dirt and water removal. It's very dependable - removing dirt, dust and moisture without leaving scratches or streaks.

- Versatile and durable
- Coated fleece: Highly absorbent & robust
- Lint-free & streak-free cleaning
- Gentle on surfaces
- Water absorption > 900%

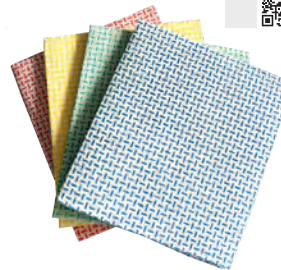

Size   Weight	Item-No.	Unit
35 x 40 cm   ca. 140 g/m <sup>2</sup>	AUT3540BL	20x10 pcs.
	AUT3540GR	
	AUT3540GE	
	AUT3540RO	



## NON-WOVEN GENERAL PURPOSE CLOTH

40° - 95°



STANDARD 100



### BLUE/GREEN/YELLOW/PINK/WHITE

Universally applicable, lint-free cleaning cloths that impress with their high quality, durability and versatility. The cloths reliably absorb dirt, dust and liquids and are characterised by their high absorbency and excellent dirt pick-up.

- For universal use: For almost all surfaces
- Suitable for dry, damp and wet applications as well as for **disinfection**
- Highly absorbent: Excellent dirt pick-up with no linting
- Washable and reusable
- Very robust and durable

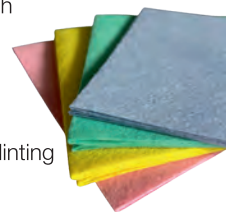

Size   Weight	Item-No.	Unit
36 x 40 cm   ca. 110 g/m <sup>2</sup>	VA3640BL110	20x10 pcs.
	VA3640GR110	
	VA3640GE110	
	VA3640RO110	
	VA3640WE110	



## NON-WOVEN FLOOR CLOTH

40° - 95°

### BLUE/GREEN/ORANGE

Specially designed for cleaning floors and impress with their high absorbency, excellent dirt pick-up and robust and durable quality. They are suitable for almost all smooth floor surfaces and can be used dry, damp or wet.

- Highly absorbent floor cloth: reliably absorbs liquids
- High dirt pick-up: Cleans smooth floor surfaces effectively and lint-free
- Washable, highly durable and long-lasting

Size   Weight	Item-No.	Unit
50 x 70 cm   ca. 160 g/m <sup>2</sup>	VB5070BL160	100 pcs.
	VB5070GR160	
	VB5070OR160	



Available in additional sizes and weights upon request.

# SPECIALAL PRODUCTS



# SPECIAL PRODUCTS



## TIGER

pH 9,1-9,5



### HIGH-PERFORMANCE UNIVERSAL DEEP CLEANER

Dissolves all water-soluble coatings, encrustations, care product residues and soiling on almost all water-resistant and alkali-sensitive floor coverings.

- Removes water-soluble, metal-crosslinked, metal salt-free coatings
- Fast effectiveness and residue-free removal

Container	Item No.	Unit
10 l Canister	01203	1x10 l



## ELITE 29 MATT

pH 8,5

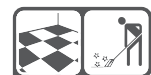

### DISINFECTANT- AND ALCOHOL RESISTANT FLOOR COATING WITH SATIN EFFECT

Ideal for protecting floor coverings in areas where **surface and hand sanitisers** are frequently used.

- Durable, easily restorable result
- Recoating possible without prior basic cleaning

Container	Item No.	Unit
5 l Canister	01156-05	1x5 l



## ELITE 29

pH 8,5

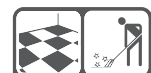

### DISINFECTANT- AND ALCOHOL RESISTANT FLOOR COATING WITH HIGH-GLOSS EFFECT

Ideal for protecting floor coverings in areas where **surface and hand sanitisers** are frequently used.

- Durable, easily restorable result
- Recoating possible without prior basic cleaning

Container	Item No.	Unit
5 l Canister	01152-05	1x5 l



## TERMINATOR® RTU

pH 12



### READY-TO-USE POWER SPRAY CLEANER

Removes stubborn dirt from washable surfaces.

- Powerful spray cleaner
- Removes grease, oil, ink and colour pencil residues, lipstick, heel marks, tyre marks and smoke deposits
- Ideal for cleaning glass frames
- 500 ml spray bottle with practical spray head

Container	Item No.	Unit
500 ml Bottle	01223	20x500 ml
5 l Canister	01224	1x5 l



## PROFI MICROFIBER WINDOW CLOTH EXTRA LARGE

40° - 95°

### BLUE

"A must for glass cleaning". This cloth enables streak-free and lint-free cleaning of glass, mirrors and chrome.

- Above-average service life
- Double-stitched edge protection with high-quality binding tape
- Maximum absorption of dirt and water
- Super absorbent: absorbs 8 times its own weight in liquid

Size   Weight	Item-No.	Unit
50 x 70 cm   ca. 105 g/Cloth	PMT5070BL	15x10 pcs.



## FLOOR-CLEAN MICROFIBER FLOOR CLOTH

40° - 95°

### BLUE

The lint-free, grease-absorbing and washable microfibre floor cloth for all floors: tiles, stone, parquet, laminate and PVC floors.

- Above-average service life
- Double-stitched edge protection with high-quality binding tape
- Maximum absorption of dirt and water

Size   Weight	Item-No.	Unit
50 x 60 cm   ca. 88 g/Cloth	ABT5060BL	15x10 pcs.



## KIM PLUS 30 SINGLE BUCKET TROLLEY

### BLUE/GREEN/YELLOW/RED/BLACK WITH PRESS

An excellent companion for efficient and hygienic cleaning. Thanks to the four smooth-running 360° swivelling wheels the single with bucket trolley can be moved easily and conveniently. Robust and user-friendly design.

- Incl. 2 containers: fresh water (30 litres), dirty water (12 litres)
- Incl. 1 x ECOBLACK plastic wringer in black

Size	Item-No.	Unit
500 x 308 x 800 mm	KLT25BL	1 Set
	KLT25GR	
	KLT25GE	
	KLT25RO	
	KLT25SC	



Dirty water (12 litres)  
Fresh water (30 litres)



**Gross weight:** 7,50 kg  
**Net weight:** 5,50 kg

## ECOBLACK 45

### DOUBLE BUCKET TROLLEY WITH STORAGE TRAY

Thanks to the four smooth-running 360° swivelling wheels, the double bucket trolley can be moved easily and conveniently. Robust and user-friendly design.

- Black, robust plastic frame made from recycled materials
- 2 x 20 litre plastic buckets in black with handles in blue and red
- ECOBLACK plastic wringer in black
- Handle for guiding the cleaning trolley with holder for aluminium handle
- Side shelf for mop holder

Size	Item-No.	Unit
710 x 510 x 950 mm	EB45RC	2 Set's



with plastic storage tray



**Gross weight:** 10,00 kg  
**Net weight:** 8,30 kg

## ECOBLACK 70

### SERVICE TROLLEY WITH STORAGE TRAY

Ideal for quick and easy cleaning of floors and surfaces. Robust and user-friendly design.

- Black, robust plastic frame made from recycled materials
- All 4 wheels are smooth-running and swivel 360°
- 1 x 20 litre plastic bucket in black with handle in red
- FlexPress plastic wringer in black
- 70 litre waste/laundry bag with lid and zip, including side pocket for accessories
- Side shelf for mop holder

Size	Item-No.	Unit
710 x 630 x 1030 mm	EB70RC	2 Set's



with plastic storage tray



**Gross weight:** 13,00 kg  
**Net weight:** 11,00 kg



# SPECIAL PRODUCTS



## ECOBLACK 100

### SERVICE TROLLEY

Ideal for quick and easy cleaning of floors and surfaces. Robust and user-friendly design.

- Black, robust plastic frame made from recycled materials
- All 4 wheels are smooth-running and swivel 360°
- 2 x 20 litre plastic buckets in black with handles in blue and red
- 2 x 8 litre plastic buckets in black with handles in blue and red
- ECOBLACK plastic wringer in black
- 70 litre waste/laundry bag with lid and zip, including side pocket for accessories
- Side shelf for mop holder

Size	Item-No.	Unit
750 x 680 x 1140 mm	EB100RC	1 Set



**Gross Weight: 16,80 kg**  
**Net Weight: 14,80 kg**



## ECOBLACK 120

### SERVICE TROLLEY

Ideal for quick and easy cleaning of floors and surfaces. Robust and user-friendly design.

- All 4 wheels are smooth-running and swivel 360°
- Black, robust plastic frame
- 2 x plastic boxes in black with lids in blue and red
- 2 x 8 litre plastic bins in black with handles in blue and red
- Waste/laundry bag with lid and zip, incl. side pocket
- Side shelf for mop holder

Size	Item-No.	Unit
730 x 600 x 1140 mm	EB120RC	1 Set



**Gross Weight: 17,00 kg**  
**Net Weight: 15,00 kg**



## ECOBLACK 140

### SERVICE TROLLEY

Ideal for quick and easy cleaning of floors and surfaces. Robust and user-friendly design.

- All 4 wheels are smooth-running and swivel 360°
- Black, robust plastic frame
- 2 x plastic boxes in black with lids in blue and red
- 4 x 6 litre plastic bins in black with handles in blue, green, yellow, red in cupboard with manually lockable lid incl. shelf for work plan
- Waste/laundry bag with lid and zip, incl. side pocket
- Side shelf for mop holder

Size	Item-No.	Unit
740 x 600 x 1100 mm	EB140RC	1 Set



**Gross Weight: 22,75 kg**  
**Net Weight: 20,75 kg**



## ECOBLACK 150

### SERVICE TROLLEY

Ideal for quick and easy cleaning of floors and surfaces. Robust and user-friendly design.

- All 4 wheels are smooth-running and swivel 360°
- Black, robust plastic frame
- 2 x plastic boxes in black with lids in blue and red
- 4 x 6 litre plastic bins in black with handles in blue, green, yellow, red in cupboard with manually lockable lid incl. shelf for work plan
- 2 x waste/laundry bags with lid and zip, incl. side pocket
- Side shelf for mop holder

Size	Item-No.	Unit
1030 x 600 x 1100 mm	EB150RC	1 Set



**Gross Weight: 25,50 kg**  
**Net Weight: 23,50 kg**

## BORA MEDICAL 750

### HYGIENE TROLLEY

This hygiene trolley with closed system was specially developed for cleaning in the healthcare sector. Impresses with its stability and user-friendliness.

- Black, robust plastic frame made from recycled materials
- All 6 wheels are smooth-running and swivel 360°
- 2 x 20 litre plastic buckets in black with handles in blue and red
- 4 x 6 litre plastic buckets with sieve for preparing the cloths in black with handles in blue, green, yellow, red in cabinet with manually lockable lid incl. shelf for work plan
- 1x ECOBLACK plastic press in black
- 1x plastic tray in black, 1x plastic box in black with lid in turquoise
- With sturdy plastic doors, manually lockable (key)
- Waste/laundry bag with lid in a second lockable cupboard
- Side shelf for mop holder

Size	Item-No.	Unit
1415 x 600 x 1115 mm	B750MD	1 Set



**Gross Weight: 41,00 kg**  
**Net Weight: 39,00 kg**



**Specially designed for the health care sector**



## BORA MEDICAL 750 X-LINE

### HYGIENE TROLLEY WITH BOX SYSTEM

Model extension of the BORA MEDICAL 750 with boxes and closed system for use with prepared wipe covers and cloths for the X-LINE CLEANING system.

Size	Item-No.	Unit
1415 x 600 x 1115 mm	MD750BOX	1 Set



**Gross Weight: 40,00 kg**  
**Net Weight: 38,00 kg**



**WITH BOX SYSTEM**

### X-LINE DUO MOP BOX

The BORA MEDICAL 750 X-LINE hygiene trolley for the preparation system is equipped with either 2 X-LINE SINGLE MOP BOXES (BLUE or RED) or 1 X-LINE DUO MOP BOX (GREY).

### X-LINE SINGLE MOP BOX



# SPECIAL PRODUCTS



## BORA TOOLS HOLDER

### DEVICE HOLDER FOR ACCESSORIES

Holder for handles with two additional hanging hooks. Practical, stable and space-saving.

- 400 mm: Suitable for up to 5 devices
- 520 mm: Suitable for up to 6 devices

Size	Item-No.	Unit
400 mm	TH400	1 pcs.
520 mm	TH520	



## PREMIUM-LINE DISPOSAL BAG



Available in 5 colours, ideal for waste separation in different areas!

Size	Item-No.	Unit
760 x 1000 mm 120 litres	PLS120BL	25 pcs.
	PLS120GR	
	PLS120GE	
	PLS120RO	
	PLS120GU	



Seamless base for longer lifetime & no gaps

The high-quality disposal bag offers enough space for transporting soiled textiles, mops or waste. It is made of **hard-wearing polyester**, which is both robust and durable. Thanks to the specially developed **seamless construction** of the base, the disposal bag can be filled without worrying about unwanted tears. Thanks to its optimal dimensions and practical design, the disposal bag can be conveniently attached to cleaning trolleys and used for hygienic disposal during daily cleaning work. The bag is washable at 30-60° C, making it reusable and, compared to plastic bin liners, an environmentally friendly and economical aid that ensures tidiness and cleanliness.

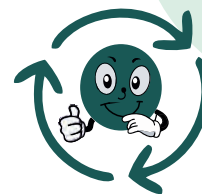

Nahtlose Bodenfläche

### PLASTIC GARBAGE BAGS

- Are mostly used as disposable garbage bags
- Cause huge mountains of waste
- It takes between 100 and 500 years for a plastic bag to slowly break down into harmful small parts (microplastics)

### PREMIUM-LINE DISPOSAL BAG

- Specially developed seamless base
- Made from hardwearing polyester that is robust and durable
- Washable and reusable
- Environmentally friendly and economical

## SUNSHINE ProPAD 3IN1

### CLEANING, POLISHING AND UHS-POLISHING

Unlike conventional floor pads which only clean, the SUNSHINE ProPAD 3IN1 delivers brilliant results without any additional steps. It is ideal for efficient and thorough maintenance cleaning with impressive sustainable performance. With the ARCORA SUNSHINE ProPAD 3IN1 you can effortlessly clean up to **65,000 m<sup>2</sup>** of floor space – efficiently, sustainably and reliably.

- Multiple steps combined in one pad: cleaning, polishing and ultra-high-speed polishing 3IN1
- Cleaning and polishing in one step
- 4-6 times longer lasting and up to 80% cost savings
- Environmentally friendly cleaning without chemicals, **ONLY WITH WATER**
- Brilliant results

It cleans and polishes coated as well as uncoated floors particularly effectively. Thanks to the unique 12,000-grit finish, coated surfaces are treated optimally. The pad is suitable for both wet cleaning and dry polishing. It is compatible with scrubber dryers (150–600 rpm), ultra-high-speed polishing machines (UHS 1500 to UHS 3000 rpm), oscillating and orbital machines, as well as scrubber robots.



Size	Item-No.	Unit
8" = 203 mm	SPP203GU	10 pcs.
9" = 228 mm	SPP228GU	
10" = 254 mm	SPP254GU	
11" = 280 mm	SPP280GU	
13" = 330 mm	SPP330GU	
14" = 356 mm	SPP356GU	5 pcs.
15" = 381 mm	SPP381GU	
16" = 406 mm	SPP406GU	
17" = 432 mm	SPP432GU	
20" = 508 mm	SPP508GU	

other sizes on request



Made from 100% recycled polyester and natural hair

**THREE FUNCTIONS, ONE PAD – MAXIMUM EFFICIENCY**



## PU-PAD LIGHT MIT WATERDROP SYSTEM

### MAINTENANCE CLEANING WITH SMALL SCRUBBER DRYERS

For maintenance cleaning of all hard floors and resilient floors. Especially suitable for smaller scrubber-driers. The waterdrop system ensures better water distribution and dirt pick-up as well as easy the machine glides easily over the floor.

- Suitable for all water-resistant floor coverings
- Particularly robust and unbreakable
- Area coverage of up to 100,000 m<sup>2</sup>
- Environmentally friendly due to the exclusive use of recycled products

Size	Item-No.	Size	Item-No.	Unit
8" = 203 mm	PU203LG	15" = 381 mm	PU381LG	5 pcs.
9" = 228 mm	PU228LG	16" = 406 mm	PU406LG	
10" = 254 mm	PU254LG	17" = 432 mm	PU432LG	
11" = 280 mm	PU280LG	18" = 457 mm	PU457LG	
12" = 305 mm	PU305LG	19" = 483 mm	PU483LG	
13" = 330 mm	PU330LG	20" = 508 mm	PU508LG	
14" = 356 mm	PU356LG	21" = 533 mm	PU533LG	

other sizes on request

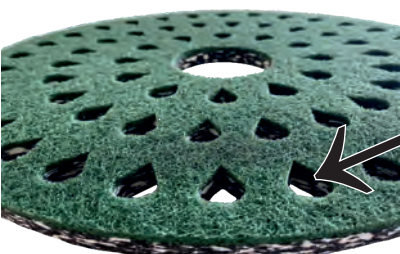
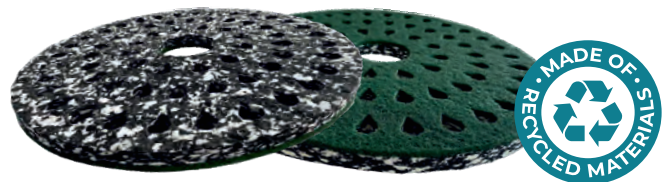

### Waterdrop System

#### Plus-Minus effect

- Improved gliding over the floor
- Better dirt absorption
- Better water distribution & saving



## SUPERPAD BLACK

### WET DEEP CLEANING ON INSENSITIVE COVERINGS

Aggressive pad for the quick and thorough removal of old coatings on insensitive floor coverings with water. Removal of stubborn metal cross-linked coatings.

- Cleans right down to the original surface
- There is a risk of damage to the floor covering!

Size	Item-No.	Unit
17"= 432 mm	SP432SC	5 pcs.



## SUPERPAD DARK BROWN

### DRY DEEP CLEANING ON INSENSITIVE COVERINGS

For dry deep cleaning on non-sensitive floor coverings and dry care film restoration on PVC and linoleum.

- Cleans right down to the original surface
- There is a risk of damage to the floor covering!

Size	Item-No.	Unit
17"= 432 mm	SP432DBR	5 pcs.



## SUPERPAD GREEN

### DEEP CLEANING ON SENSITIVE SURFACES OR MAINTENANCE CLEANING ON NON-SENSITIVE COVERINGS

For deep cleaning on sensitive floor coverings and for maintenance cleaning on non-sensitive floor coverings.

- Interval cleaning on PVC, rubber and elastomers
- Cleaning with scrubber dryers on PVC floors

Size	Item-No.	Unit
17"= 432 mm	SP432GR	5 pcs.



## SUPERPAD BLUE

### DEEP OR INTERVAL CLEANING ON SENSITIVE FLOOR COVERINGS

Ideally suited for deep cleaning and interval cleaning on sensitive floor coverings such as linoleum, PVC, parquet, natural stone, cork.

- Suitable for cleaning with scrubber dryers

Size	Item-No.	Unit
17"= 432 mm	SP432BL	5 pcs.



## SUPERPAD RED

### MAINTENANCE CLEANING WITH SCRUBBER DRYERS OR SPRAY CLEANERS UP TO 400 RPM

For daily maintenance cleaning with scrubber dryers.

- For intermittent cleaning and cleaning with scrubber dryers and the spray cleaner method

Size	Item-No.	Unit
17"= 432 mm	SP432RO	5 pcs.



## SUPERPAD BEIGE

### MAINTENANCE CLEANING ON SENSITIVE FLOOR COVERINGS OR DRY POLISHING UP TO 400 RPM

The soft fibers make it ideal for maintenance cleaning on sensitive floor coverings and for polishing parquet and cork.

- Also suitable for massaging in waxes and oils on parquet/cork

Size	Item-No.	Unit
17"= 432 mm	SP432BE	5 pcs.



## SUPERPAD WHITE

### DRY POLISHING UP TO 400 RPM OR MASSAGING IN WAXES AND OILS ON PARQUET/CORK

The soft fibers make it ideal for maintenance cleaning on sensitive floor coverings and for polishing parquet and cork.

- A particularly high shine can be achieved during dry polishing can

Size	Item-No.	Unit
17"= 432 mm	SP432WE	5 pcs.



Other sizes are available on request.

## PRO1PLUS

### PROFESSIONAL COMMERCIAL VACUUM CLEANER WITH COOLING SYSTEM

Specially developed for use in building cleaning. A powerful and reliable dry vacuum cleaner for a wide variety of floor coverings. Ideal for daily maintenance cleaning. Its robust, modern design combined with practical solutions enables efficient use with low operating costs.

- Robust and stable construction due to shockproof materials
- Durable motor with dual power options for better suction (1200/750 W)
- Airflow control valve on the handle
- Rubber-tired wheels for floor, wall and furniture protection
- Exhaust air filter cassette for cleaning exhaust air
- Auxiliary air valve for cooling the engine
- With large, handy handle for easy and safe transport
- Switchable floor nozzle to allow adaptation to different floor coverings
- Accessory storage on the device
- Parking system for floor nozzle
- 15 m power cable in bright orange with integrated manual cable winder for safe and practical cable storage
- Including floor nozzle, suction hose, 2 metal suction pipes, crevice nozzle, upholstery nozzle, brush nozzle and 2 fleece filter bags

Size   Weight	Item-No.	Unit
42 x 35 x 32 cm   7 kg	PRO1PLUS	1 Set

<b>Voltage</b>	220-240 V / 50 Hz
<b>Power</b>	750 W / 1200 W
<b>Airflow rating</b>	53 l/s
<b>Vacuum</b>	27/29 kPa
<b>Working width floor nozzle</b>	275 mm
<b>Noisel level</b>	67 dB
<b>Container capacity</b>	10 l
<b>Power supply cable</b>	15 m
<b>Effective radius</b>	19 m
<b>Hose length</b>	2,8 m
<b>Container material</b>	shockproof metal
<b>Dust bag capacity</b>	10 l
<b>Suction pipe diameter</b>	36 mm
<b>Suction hose diameter</b>	36 mm
<b>EPA filter</b>	EPA10 / HEPA13
<b>WEEE-Reg.-No.</b>	DE 82514658

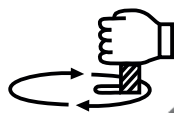

manual cable rewinder

auxiliary air valve

power switch button

parking position for floor nozzle

accessories storage

power button



### PRO1PLUS FLEECE FILTER BAG 3-PLY

#### WHITE

Tear-resistant 3-ply non-woven filter bags with optimum dirt collection.

Item-No. Unit

01313 15x10 pcs.



### PRO1PLUS PERMANENT FILTER

#### REUSABLE

Reusable textile permanent filter with optimal dirt absorption.

Item-No. Unit

OH-077 1 pcs.

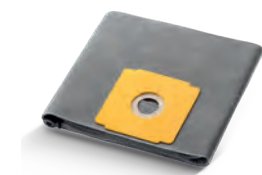

## SPECIAL PRODUCTS



### WD 36 P

#### WET/DRY VACUUM CLEANER WITH 36 LITRES CAPACITY VOLUME

Ideally suited for hotels, schools, industrial trade and public buildings.

- Highly efficient, powerful motor
- Accessory holder
- Exhaust air filter for versatile use
- Automatic float switch-off for a long service life
- Incl. dry floor nozzle, water nozzle, brush nozzle, crevice nozzle, upholstery nozzle, textile filter, suction pipe, suction hose

Size   Weight	Item-No.	Unit
50x 38 x 68,5 cm   9,6 kg	WD36P	1 Set
<b>Max. Power consumption</b>	1250 W	
<b>Container Capacity</b>	36 l	
<b>Actual capacity</b>	25 l	
<b>Water column</b>	235 mbar	
<b>Air delivery</b>	71 l/s	
<b>Cable length</b>	10 m	
<b>Noise level</b>	60 dB	



### WD 50 PD

#### WET/DRY VACUUM CLEANER WITH 50 LITRES CAPACITY VOLUME

Ideal for hotels, schools, industrial, trade and public buildings.

- Highly efficient, powerful motor
- Chassis made of impact-resistant plastic with accessory holders
- Equipped with a drain hose for emptying the container
- Exhaust air filter for cleaner air
- Automatic float switch-off for a longer life
- Incl. dry floor nozzle, water nozzle, brush nozzle, crevice nozzle, upholstery nozzle, textile filter, suction pipe, suction hose

Size   Weight	Item-No.	Unit
52,5 x 49,5 x 82,5 cm   12,5 kg	WD50PD	1 Set
<b>Max. Power consumption</b>	1450 W	
<b>Container Capacity</b>	50 l	
<b>Actual capacity</b>	35 l	
<b>Water column</b>	260 mbar	
<b>Air conveying</b>	74 l/s	
<b>Cable length</b>	10 m	
<b>Noise level</b>	62 dB	



## SD430

### SINGLE DISC MACHINE 17 INCH / 432 mm

Powerful and versatile **SD430** single-disc machine. Particularly suitable for the intensive cleaning of all types of floor coverings as well as for light polishing work. The robust construction underlines its high quality and guarantees long-term usability.

- Robust planetary gearbox
- High-quality **copper motor** for maximum durability
- Ergonomic handle for fatigue-free operation
- Robust construction for long-term use
- Complete accessory set for all surfaces
- 13-litre fresh water tank

Suitable for deep cleaning, restoration of protective coatings, periodic and routine cleaning, as well as for spray cleaning and polishing applications. In combination with ARCORA super pads, cleaning and polishing pads, sunshine pads, UHS pads, and microfiber pads, the machine can be optimally used on a wide variety of floor surfaces.

Weight	Item-No.	Unit
45,5 kg	SD430SET	1 Set

<b>Power</b>	1100 W
<b>Voltage</b>	220-240 V / 50-60 Hz
<b>Brush speed</b>	154 rpm
<b>Working width</b>	17" / 432 mm
<b>Noise level</b>	≤ 54 dB
<b>Water tank</b>	13 l
<b>Cable length</b>	12 m
<b>Weight without accessories</b>	39 kg



#### Included in delivery:

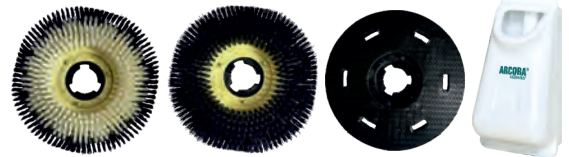

scrubbing brush, carpet cleaning brush, pad holder and fresh-water tank



## EXZENTER 500

### ECCENTRIC MACHINE

A powerful machine for efficient cleaning, polishing and finishing of surfaces, especially edges and corners. Its eccentric movements achieve uniform, shiny results while remaining extremely user-friendly. The robust design ensures reliability and durability.

- Easy to use, robust design
- Robust construction for professional use
- Especially good for corners and edges
- Includes main body, handle, water tank, cleaning pads and additional weights (2x12 kg=24 kg)

For cleaning all areas and especially good along edges and into corners.

Weight	Item-No.	Unit
67 kg	EX500SET	1 Set

<b>Power</b>	1500 W
<b>Voltage</b>	220 V / 50-60 Hz
<b>Current</b>	9,1 A
<b>Speed of rotation</b>	2834 U/min
<b>Operating capacitor</b>	30 uF/500V
<b>Start capacitor</b>	150 uF/300V
<b>Noise level</b>	<75 dB
<b>Cable length</b>	12 m
<b>Base disc size</b>	480 x 330 mm
<b>Machine with weights</b>	43+24=67 kg
<b>Handle packing size</b>	420 x 100 x 1115 mm
<b>Main body packing size</b>	485 x 500 x 395 mm



Pad size: 510x350 mm

Included in delivery



Cleaning pad red

Polishing pad white

Deep cleaning pad black

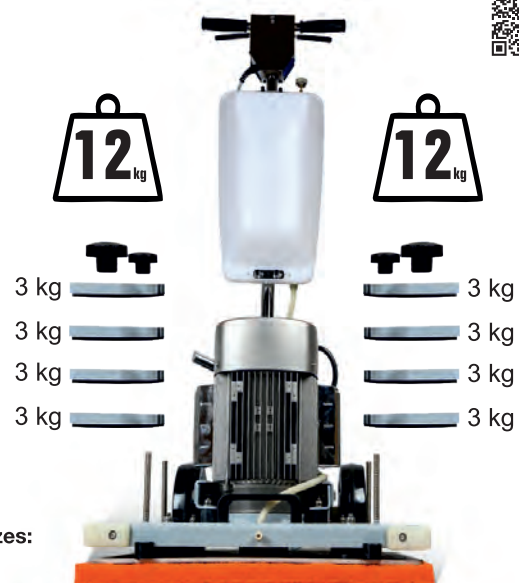

Diamond pads available on request in 510x350 mm with the following grit sizes: 1+ = 200 K, 1 = 400 K, 2 = 800 K, 3 = 1500 K, 4 = 3000 K, 5 = 8000 K

# SPECIAL PRODUCTS FOR OPERATING ROOM

## IN-BOX MICROFIBER CLOTH

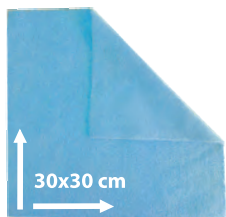

ALWAYS AT HAND!

### BLUE/GREEN/YELLOW/PINK/GREY

This practical box ensures maximum flexibility. Ideal for taking with you in mobile devices and space-saving for storage even in the smallest of spaces.

- Perfect for daily cleaning of all surfaces
- Alternative to paper towels
- Washable up to 300 times
- Always accessible - in a practical box
- Edge: ultrasonic cut → strong, stable and durable
- Content: 50 space-saving towels, each 30 × 30 cm



Size   Weight	Item-No.	Unit
30 x 30 cm   ca. 200 g/m <sup>2</sup>	BMF50BL	8 Boxes
	BMF50GR	
	BMF50GE	
	BMF50RO	
	BMF50GU	



## NON-WOVEN GENERAL PURPOSE CLOTH



OEKO  
TEX®  
STANDARD  
100

### BLUE/GREEN/YELLOW/PINK/WHITE

Universally applicable, lint-free cleaning cloths that impress with their high quality, durability and versatility. The cloths reliably absorb dirt, dust and liquids and are characterised by their high absorbency and excellent dirt pick-up.

- For universal use: For almost all surfaces
- Suitable for dry, damp and wet applications as well as for **disinfection**
- Highly absorbent: Excellent dirt pick-up with no linting
- Washable and reusable
- Very robust and durable

Size   Weight	Item-No.	Unit
36 x 40 cm   ca. 110 g/m <sup>2</sup>	VA3640BL110	20x10 pcs.
	VA3640GR110	
	VA3640GE110	
	VA3640RO110	
	VA3640WE110	



Available in additional sizes and weights upon request.

## DISPOSABLE MOP MICROFIBER

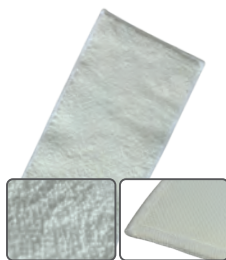
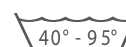

### WHITE

The mop offers high reliability wherever hygiene is a top priority. It is particularly suitable for all areas where quick, safe cleaning without the risk of recontamination is necessary. Thanks to its high-quality microfibre material, the mop enables effective and thorough cleaning. Dirt, dust and liquids are reliably absorbed.

- The disposable mop for sensitive hygiene areas
- Hygienic, fast and economical solution
- Lightweight, powerful and ready to use
- Reduces the risk of cross-contamination

Size   Weight	Item-No.	Unit
40 cm   500 g/m <sup>2</sup>	EWM40WE	500 pcs.
50 cm   500 g/m <sup>2</sup>	EWM50WE	





# SUNSHINE FLOOR CARE SYSTEMS

## ARCORA® DIAMOND CLEAN TECHNOLOGY – THE FUTURE OF FLOOR CARE

In times of so much brand diversity, one thing counts above all: creating added value, with convincing solutions. With the innovative **Diamond Clean Technology** ARCORA® offers a complete solution for cleaning, care and polishing of all floor types when used with scrubber-dryer machines and ultra-high-speed machines. Since 1992, ARCORA® has been developing modern floor care systems. Our **Diamond Clean Technology** cleans and polishes floors in one step, **without any chemical additives**.



Made from 100% recycled polyester and natural hair

### THREE FUNCTIONS, ONE PAD – MAXIMUM EFFICIENCY

Unlike conventional floor pads which only clean, the **SUNSHINE ProPAD 3IN1** delivers brilliant results without any additional steps. It is ideal for efficient and thorough maintenance cleaning with impressive sustainable performance. With the **ARCORA® SUNSHINE ProPAD 3IN1** you can effortlessly clean up to **65,000 m²** of floor space – efficiently, sustainably and reliably.

- ✓ **Multiple steps combined in one pad: cleaning, polishing and ultra-high-speed polishing 3IN1**  
Fast, efficient workflow. Only one pad instead of three.
- ✓ **Cleaning and polishing in one step**  
For coated and uncoated floors, scrubber-dryers with **150-600 rpm**
- ✓ **Ultra-high-speed polishing**  
High-speed polishing with machines from **1500 to 3000 rpm**
- ✓ **4-6 times longer lasting and up to 80% cost savings**  
Lower consumables, less storage space and labour required
- ✓ **Environmentally friendly cleaning without chemicals – ONLY WITH WATER**  
Works exclusively with water. Safe on users and floors.
- ✓ **Brilliant results**  
Visible after the very first application.



### ARCORA® SUNSHINE ProPAD 3IN1



Item-no.	Size	Item-no.	Size
SPP203GU	8"/203 mm	SPP356GU	14"/356 mm
SPP228GU	9"/228 mm	SPP381GU	15"/381 mm
SPP254GU	10"/254 mm	SPP406GU	16"/406 mm
SPP280GU	11"/280 mm	SPP432GU	17"/432 mm
SPP330GU	13"/330 mm	SPP508GU	20"/508 mm

Packaging unit: 8-11 inches: 10 pieces per box 13-20 inches: 5 pieces per box  
**Special sizes are available on request.**

#### APPLICATION

The **ARCORA® SUNSHINE ProPAD 3IN1** offers outstanding cleaning performance and efficiency. It thoroughly cleans and polishes coated and uncoated floors, delivering perfectly maintained surfaces thanks to its unique **12,000-grit structure**. Whether for wet cleaning, dry use, or high-speed polishing, the SUNSHINE ProPAD 3IN1 offers versatile applications and is compatible with scrubber dryers (**150–600 rpm**), ultra-high-speed polishing machines (**UHS 1500–3000 rpm**), as well as oscillating and orbital machines. Ideal for the future of cleaning: The SUNSHINE ProPAD 3IN1 is perfectly suited for use with **scrubbing robots**, delivering highly efficient, automated floor care at the highest standard.

#### APPLICATION AREA

Ideal for use in commercial, industrial and public areas such as shopping malls, supermarkets and airports. Suitable for coated and uncoated floors, such as concrete, natural stone, terrazzo, marble, granite, PVC and ceramic.

**Area performance up to 65,000 m²**  
**Grain size 12,000**



**Specially designed for the health care sector**



The BORA MEDICAL 750 X-LINE was developed specifically for professional cleaning requirements in healthcare settings. The hygiene trolley impresses with its high stability, well-thought-out functionality, and maximum user-friendliness. The 360° swivel, smooth-running 150 mm wheels ensure excellent maneuverability, even in tight or heavily frequented areas. The closed system with lockable cabinets and lids enables safe and hygienic storage of accessories and supports structured, safe working. The four color-coded 6-liter buckets are integrated into the cabinet and are not visible from the outside. Thanks to the integrated box system, mop covers can be efficiently pre-soaked and carried directly, which optimizes workflows and saves time. The BORA MEDICAL 750 X-LINE is largely made from environmentally friendly recycled materials (ECOBLOCK) and thus actively contributes to reducing CO<sub>2</sub> emissions.

### Design of the MEDICAL 750 X-LINE hygiene trolley with box system:

- Black, robust plastic frame made from recycled materials
- All 6 wheels are smooth-running and swivel 360°
- 3 x 20 liter mop boxes, colours as desired red or blue
- 4 x 6 liter plastic buckets in black with handles in blue, green, yellow, red in cupboard with manually lockable lid incl. storage for documents
- 1 x plastic tray in black
- 1 x plastic box in black with lid in turquoise
- With sturdy plastic doors designed specifically for healthcare, manually lockable (key)
- Waste/laundry bag 140 liter with lid in a second lockable cupboard
- Side shelf for mop and handle holder



With lockable compartment  
For e.g. documents or tablet

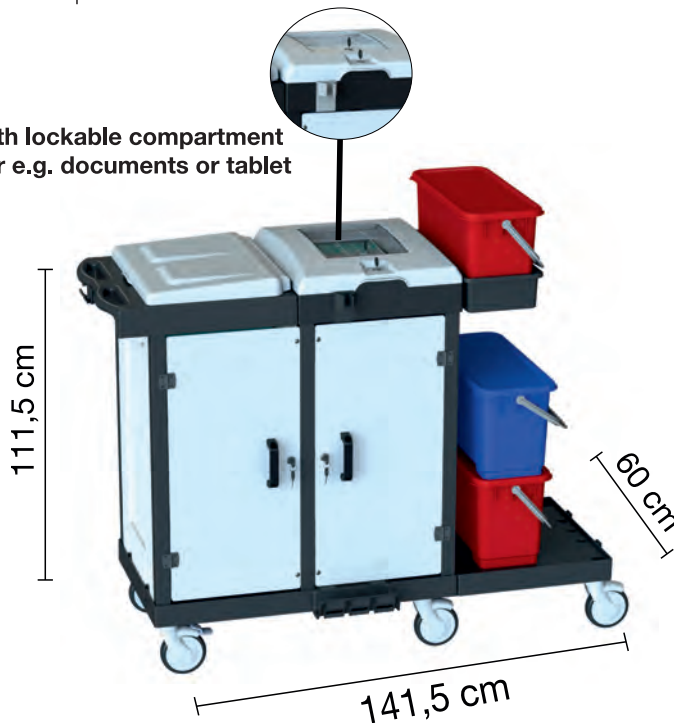

Item-No.: MD750BOX  
Unit: 1 Set

WITH BOX SYSTEM

The **BORA MEDICAL 750 X-LINE** hygiene trolley with preparation system is optionally available with two X-LINE single mop boxes (in blue or red) or one X-LINE duo mop box (in grey).



### X-LINE DUO MOP BOX GREY WITH LID INCL. BOTTOM SIEVE

Mop box for all ULTRA VELCRO mop systems in size 40 cm. Clean separation of prepared mop covers for use in different areas.

Size	Item-No.	Unit
510 x 400 x 220 mm	DUO20BOX	1 pcs.



### X-LINE SINGLE MOP BOX BLUE OR RED WITH LID

Plastic mop box for prepared mops with pockets in size 40 cm. For all ARCORA® cleaning, hygiene and system trolleys.

Volume	Item-No.	Unit
20 Liter	BOX20BL ■	1 pcs.
	BOX20RO ■	



Your partner when it comes to professional cleaning in the healthcare sector.

## SUSTAINABLE AND INNOVATIVE SOLUTIONS FOR USER-FRIENDLY CLEANING!



### Headquarters

#### ARCORA® INTERNATIONAL GmbH

Marsstrasse 9  
85609 Aschheim/Munich - Germany

Telephone: +49 (0)89/ 14 33 29 3 - 0  
Telefax: +49 (0)89/ 14 33 29 3 - 29

E-Mail: [info@arcora.de](mailto:info@arcora.de)  
Web: [www.arcora-group.com](http://www.arcora-group.com)

